



VAN OPSTAL

B e n e l u x

Van Opstal & C° n.v.

Boomsesteenweg 34, B- 2630 Aartselaar

Tel.: 03- 887.40.48 • Fax: 03- 887.76.06

E-mail: info@vanopstal.be

www.vanopstal.be

Van Opstal Nederland b.v.

Minden 56, NL- 7327 AW Apeldoorn

Tel.: 055- 543.03.33 • Fax: 055- 543.00.09

E-mail: info@vanopstal-nederland.nl

www.vanopstal-nederland.nl



CONSTRUCTIEBESLAG DIVERSEN

© Alle rechten voorbehouden.

Niets uit deze publicatie mag worden vermenigvuldigd en/of verspreid in welke vorm dan ook zonder schriftelijke toestemming van Van Opstal & C° n.v. of Van Opstal Nederland b.v..

Magneten	1
Afdekkoppen	4
Afdekkappen voor schroeven	5
Ophangers	6
Afkanband	7
Bed- en tafelbeslag	8
Drevels	9
Beschermhoeken	10
Hoeken	11
Meubelwig	12
Inklapbeslag	13
Pluggen	14
Rugwandklem	15
Schapidragers	16
Schroeven	23
Moeren	30
Sloten	31
Kastgrendel	45
Kastsluitingen	46
Deurrechter	49
Stellijsten	50
Stoeldoppen en -geleiders	53
Inhangbeslag	56
Verbindingsplaatjes	57
Hoekverbindingen	58
Kastverbindingen	60
Keukenbladverbinders	64
Andere verbinders	65
Vlechtwerk	66
Luchtroosters	68
Kroonlijsten	69
Balusters	70
Sets draaibodems systeem 1	71
Sets draaibodems systeem 2	75
Sets draaibodems systeem 3	77
Sets draaibodems systeem 4	79
Smove deurdempers	81
Andere deurdempers	86
Deurbeschermer	89
Consolen	90
Profielen voor aluminium deurframe	94
Greeprofielen	100
Profielen voor werkbladen	103
Afwerkprofielen	104
Aluminium kaderprofiel	106
Aluminium plintprofiel	108
Uittrektafelbeslag	110

BELGIE:  **0800 - 97.400**
GRATIS

NEDERLAND:  **0800 - 0221215**
GRATIS

FAX OP AANVRAAG*

* Voorbehouden voor installateurs.

Uw klantnummer:

--	--	--	--	--	--

1. Bel 0800- 97.400 voor België of 0800- 022.12.15 voor Nederland.
2. Voer uw klantnummer in, gevolgd door de * toets.
Uw klantnummer bestaat uit maximaal 6 cijfers.
Het is niet nodig om de nul-cijfers die uw klantnummer voorafgaan in te toetsen.
Voorbeeld: klantnummer 001234=1234**
3. Voer de artikelnummers in waarvoor u een offerte wenst.
Een artikelnummer bestaat steeds uit 6 cijfers.
Hier moet U wel de nul-cijfers die voorafgaan intoetsen.
Voorbeeld: 038412=038412
Elke correcte ingave wordt door de computer bevestigd.
Deze verzoekt U het volgende artikelnummer in te geven.
U kunt tot 20 artikelnummers opvragen.
Wenst U uw lijst met artikelen af te sluiten, druk dan op de * toets.
4. Na verwerking van de gegevens, ontvangt U, binnen de 5 minuten,
een offerte via het faxnummer dat in ons adressenbestand werd opgenomen.

MAGNETEN

MAGNETEN



Magneten type 211.030

Bestelnr.	Afwerking	Draagkracht	Verpakking
012179	bruin	3 KG	20
012177	wit	3 KG	20
012182	bruin	4 KG	20
012180	wit	4 KG	20
012185	bruin	6 KG	20
012183	wit	6 KG	20



Magneten type 214.230

Bestelnr.	Afwerking	Draagkracht	Verpakking
012195	bruin	6 KG	20
012193	wit	6 KG	20

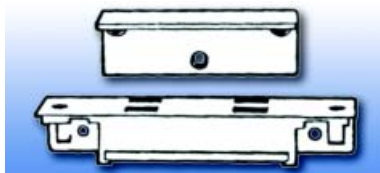

Magneten type 222.410

Bestelnr.	Afwerking	Draagkracht	Verpakking
012202	wit	12 KG	20

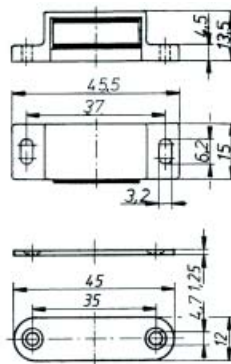

Magneten type 271/2L

Bestelnr.	Afwerking	Draagkracht	Verpakking
010395	bruin	3-4 KG	50
010394	wit	3-4 KG	50

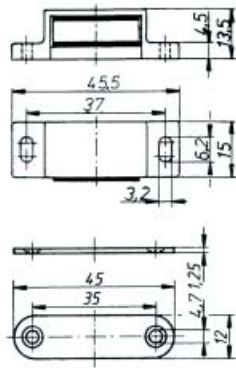

Magneten type 272/2L

Bestelnr.	Afwerking	Draagkracht	Verpakking
010403	bruin	4-5 KG	50
010401	wit	4-5 KG	50

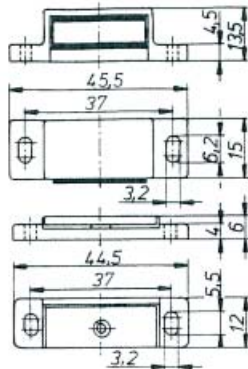

Magneten type 274

Bestelnr.	Afwerking	Draagkracht	Verpakking
010433	bruin	3-4 KG	50
010432	wit	3-4 KG	50

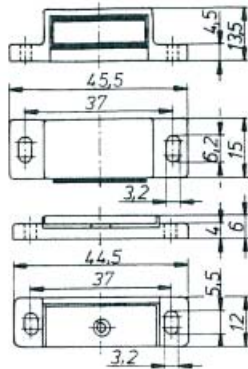

Magneten type 275

Bestelnr.	Afwerking	Draagkracht	Verpakking
010435	bruin	5-6 KG	50
010434	wit	5-6 KG	50

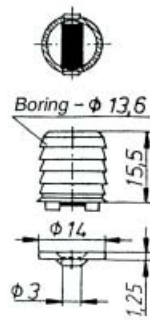
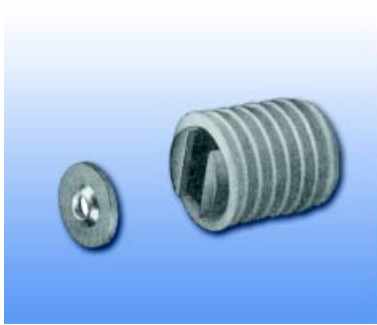
**Magneten type 273**

- magneet om in te boren

Bestelnr.	Afwerking	Draagkracht	Verpakking
010429	bruin	2,5-3,5 KG	50
010428	wit	2,5-3,5 KG	50

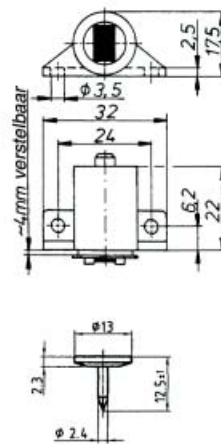
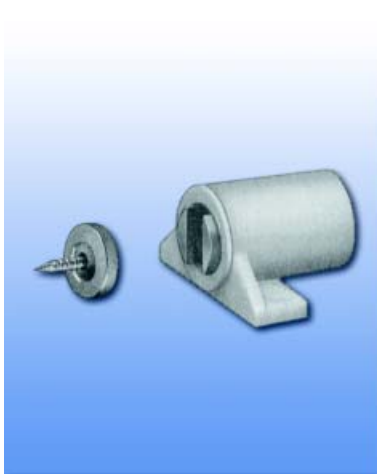
**Magneten type 273 VS**

Bestelnr.	Afwerking	Draagkracht	Verpakking
010411	bruin	3-4 KG	50
010410	wit	3-4 KG	50

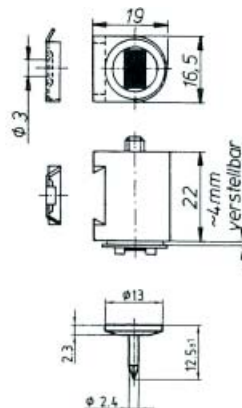
**Magneten type 2730 A**

Bestelnr.	Afwerking	Draagkracht	Verpakking
010415	bruin	3-4 KG	50
010414	wit	3-4 KG	50

AFDEKSTOPPEN

AFDEKSTOPPEN

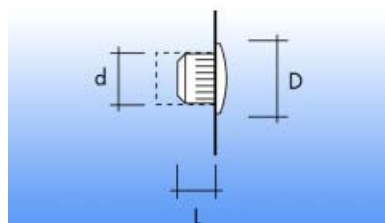

Afdekstop type A

Bestelnr.	Afwerking	d	D	L	Verpakking
003035	beige	5 mm	8 mm	5 mm	5000
003038	beige	10 mm	15 mm	5 mm	10000
003039	beige	12 mm	16 mm	5 mm	1000
003022	bruin	3 mm	15 mm	6 mm	10000
003496	bruin	5 mm	8 mm	5 mm	5000
003024	bruin	6 mm	8 mm	5,5 mm	10000
003025	bruin	8 mm	13 mm	5 mm	5000
003026	bruin	10 mm	15 mm	5 mm	5000
003027	bruin	12 mm	16 mm	5 mm	10000
003462	donker bruin	10 mm	15 mm	5 mm	5000
001940	wit	3 mm	15 mm	6 mm	10000
013187	wit	4,9 mm	7,5 mm	4 mm	100
001941	wit	5 mm	8 mm	5 mm	5000
001942	wit	6 mm	8 mm	5,5 mm	min.5000
001943	wit	8 mm	13 mm	5 mm	5000
001944	wit	10 mm	15 mm	5 mm	5000
001945	wit	12 mm	16 mm	5 mm	1000
003028	zwart	3 mm	15 mm	6 mm	10000
003029	zwart	5 mm	8 mm	5 mm	5000
003030	zwart	6 mm	8 mm	5,5 mm	5000
003031	zwart	8 mm	13 mm	5 mm	1000
003032	zwart	10 mm	15 mm	5 mm	5000
003033	zwart	12 mm	16 mm	5 mm	10000

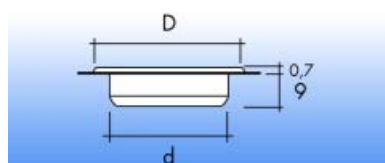

Afdekstop type B

Bestelnr.	Afwerking	d	D	Verpakking
028366	bruin	35 mm	38,5 mm	4000
028365	wit	35 mm	38,5 mm	4000

AFDEKKAPPEN VOOR SCHROEVEN

AFDEKKAPPEN VOOR SCHROEVEN MET KOPBORING

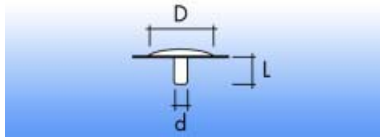

Afdekkappen voor schroeven met kopboring
type A

Bestelnr.	Afwerking	d	D	L	Verpakking
003094	beige	2,9 mm	15 mm	6,5 mm	1000
003095	donker bruin	2,9 mm	15 mm	6,5 mm	1000
003093	licht bruin	2,9 mm	15 mm	6,5 mm	1000
003190	grijs	2,9 mm	15 mm	6,5 mm	100
001691	wit	2,9 mm	15 mm	6,5 mm	2000
003096	zwart	2,9 mm	15 mm	6,5 mm	1000

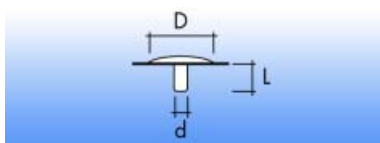

Afdekkappen voor schroeven met kopboring
type B

- pozidrive voor schroef met kopboring

Bestelnr.	Afwerking	d	D	L	Verpakking
003470	beige	2,5 mm	12 mm	7 mm	1000
003468	bruin	2,5 mm	12 mm	7 mm	1000
003471	licht grijs	2,5 mm	12 mm	7 mm	1000
003467	wit	2,5 mm	12 mm	7 mm	1000
003469	zwart	2,5 mm	12 mm	7 mm	1000

OPHANGERS

OPHANGERS

Ophanger type 602430

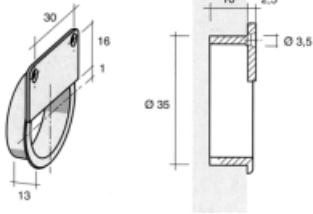

Bestelnr.	Afwerking	-	Verpakking
013241	wit	-	400

AFKANTBAND

AFKANTBAND

Melamin met lijm

Bestelnr.	Afwerking	Breedte	Op rol van	Verpakking
011699	wit	22 mm	50 m	min. 1100 m
011700	wit	24 mm	50 m	min.3000 m
013057	wit met structuur	22 mm	50 m	50 m
013070	wit met structuur	24 mm	50 m	min.50 m
013071	wit met structuur	50 mm	50 m	min.1000 m

BED- EN TAFELBESLAG

BEDBESLAG

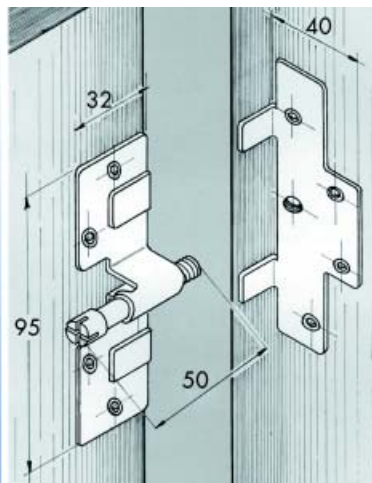

Hoekverbinding type 0561.01.098

Bestelnr.	Afwerking	-	Verpakking
012335	-		set

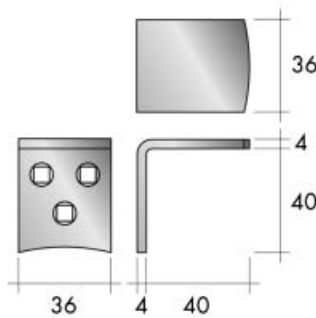

Bedhaak type 181

Bestelnr.	Afwerking	-	Verpakking
010917	verzinkt		50

TAFELBESLAG

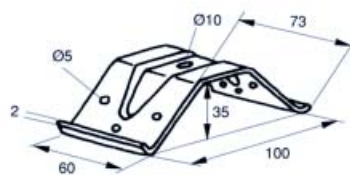

Tafelverbinding type 0556.01.098

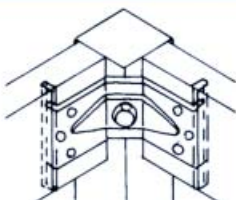

Bestelnr.	Afwerking	-	Verpakking
056095	-		1

DREVELS

DREVELS



Houten drel type ROX

Bestelnr.	Afwerking	Lengte	Diameter	Verpakking
012988	beuk	30 mm	6 mm	10 KG
010946	beuk	21 mm	8 mm	10 KG
010947	beuk	30 mm	8 mm	10 KG
010948	beuk	35 mm	8 mm	10 KG
010949	beuk	40 mm	8 mm	10 KG
010951	beuk	50 mm	8 mm	10 KG
010959	beuk	25 mm	10 mm	10 KG
010960	beuk	30 mm	10 mm	10 KG
010961	beuk	35 mm	10 mm	10 KG
010962	beuk	40 mm	10 mm	10 KG
010964	beuk	50 mm	10 mm	10 KG

Spandrel type 44.0850
- op strip van 20 stuks

Bestelnr.	Afwerking	Lengte	Diameter	Verpakking
021418	wit	11 mm	5,5 mm	14000

BESCHERMHOEKEN

BESCHERMHOEKEN

Beschermhoek type 35.0440 en 35.1780

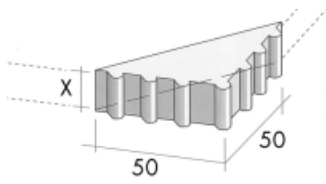

Bestelnr.	Afwerking	Voor een blad van (X)	Type	Verpakking
013413	zwart	19 mm	35.1780	550
012938	zwart	40 mm	35.0440	550

Beschermhoek type 35.0200

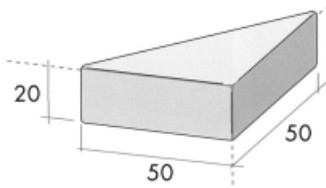

Bestelnr.	Afwerking	Voor een blad van	Verpakking
013191	zwart	20 mm	1100

HOEKEN

RAAMHOEKEN

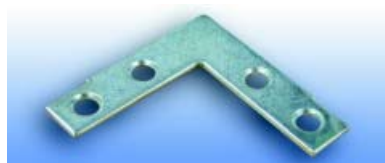

Raamhoek type 6006

Bestelnr.	Afwerking	Afmetingen	Verpakking
012317	verzinkt	40 x 40 mm	min.50
012318	verzinkt	50 x 50 mm	min.50
012319	verzinkt	65 x 65 mm	min.50
012320	verzinkt	75 x 75 mm	min.50

STOELHOEKEN



Stoelhoek type 6005

Bestelnr.	Afwerking	Afmetingen	Verpakking
010933	verzinkt	25x25 mm	50
010934	verzinkt	30x30 mm	50
010935	verzinkt	40x40 mm	50
010936	verzinkt	50x50 mm	50
010937	verzinkt	65x65 mm	50
010938	verzinkt	75x75 mm	50
010939	verzinkt	90x90 mm	50
010940	verzinkt	100x100 mm	50
010941	verzinkt	125x125 mm	50
010942	verzinkt	150x150 mm	50

MEUBELWIG

MEUBELWIG



Meubelwig type 460.000

Bestelnr.	Afwerking	Lengte	Breedte	Dikte	Verpakking
013094	bruin	100 mm	20 mm	1 tot 8 mm	1000

INKLAPBESLAG

INKLAPBESLAG

Inklapbeslag type 7672.9010

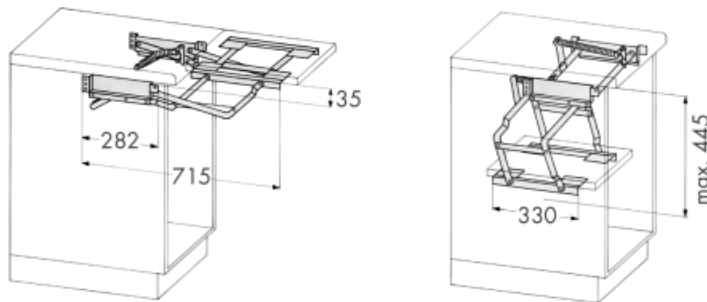

Bestelnr.	Afwerking	Inbouwhoogte	Verpakking
035043	wit	445 mm	I

Vervangveren voor inklapbeslag type 7672.9010

Bestelnr.	Afwerking	-	Verpakking
037894	-		I

PLUGGEN

PLUGGEN

Delta plug

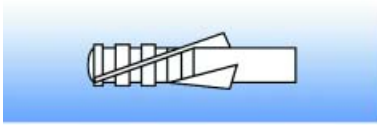

De spiraal houdt de schroef in het midden waardoor de plug naar alle kanten spreidt.



De plughelften kunnen door elkaar schuiven door verlopende insnijdingen.



Zo zetten de Delta vleugels zich vast, hier in zachte steen.



Zeer geschikt voor door en door montage en in holle wanden.

Bestelnr.	Afwerking	Diameter	Verpakking
001902	nylon	6	1000
001904	nylon	8	800
001905	nylon	10	min.3200

RUGWANDKLEM

RUGWANDKLEM

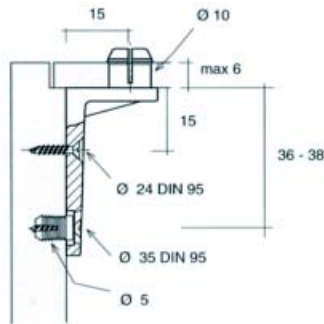

Rugwandklem type 57.0570

Bestelnr.	Afwerking	-	Verpakking
013151	wit		4500

SCHAPDRAGERS

SCHAPDRAGERS

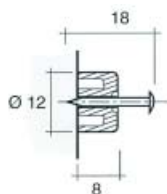

Schapdrager type Atlan 999

Bestelnr.	Afwerking	Hoogte	Diameter	Verpakking
011022	bruin	7,5 mm	12 mm	6000
011021	wit	7,5 mm	12 mm	6000

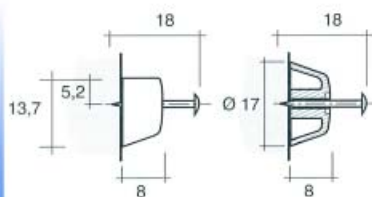

Schapdrager type Atlan 615

Bestelnr.	Afwerking	Hoogte	Diameter	Verpakking
012805	beige	7,5 mm	17 mm	4000
011024	bruin	7,5 mm	17 mm	4000
011023	wit	7,5 mm	17 mm	4000

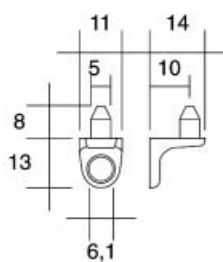

Schapdrager met schroef type 3013

- per set van 4 stuks
- inclusief schroeven

Bestelnr.	Afwerking	Omschrijving	Verpakking
010995	vernikkeld	met euroschroeven	I
010996	vernikkeld	met houtschroeven	I

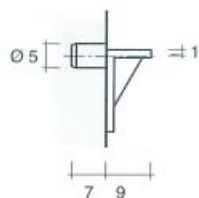
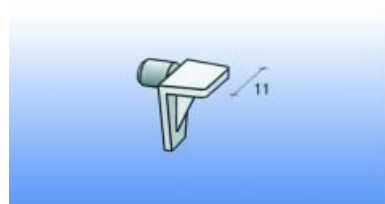

Schapdrager type 34.0010

Bestelnr.	Afwerking	-	Verpakking
013188	zwart		5000

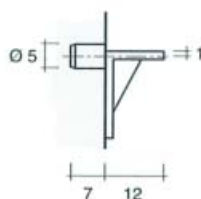

Schapdrager type 34.0030

Bestelnr.	Afwerking	-	Verpakking
021465	beige		5000
021464	bruin		5000
021463	wit		5000

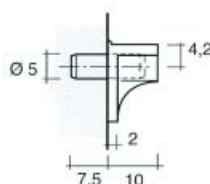

Schapdrager type 34.0040

Bestelnr.	Afwerking	-	Verpakking
021446	transparant		3000
012933	wit		3000

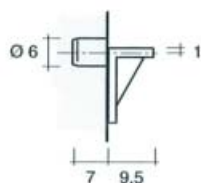

Schapdrager type 34.0050

Bestelnr.	Afwerking	-	Verpakking
021466	wit		5000

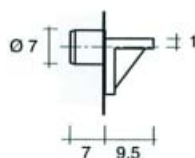

Schapdrager type 34.0100

Bestelnr.	Afwerking	-	Verpakking
012313	bruin		5000
011005	wit		5000

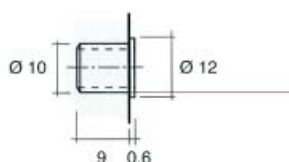

Huls voor schapdrager type 34.0100

Bestelnr.	Afwerking	-	Verpakking
012314	bruin	-	5000
011006	wit	-	5000

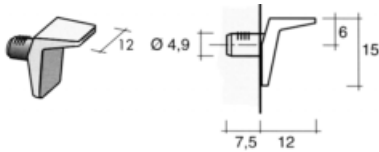

Schapdrager type 99.6350

Bestelnr.	Afwerking	-	Verpakking
013233	vernikkeld		8000

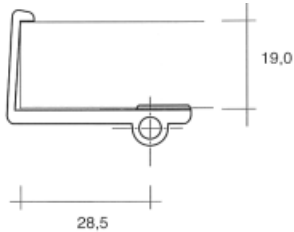

Schapdrager type 34.1230/34.1240

Bestelnr.	Afwerking	Links/rechts	Type	Verpakking
013194	wit	links	34.1240	750
013087	wit	rechts	34.1230	750

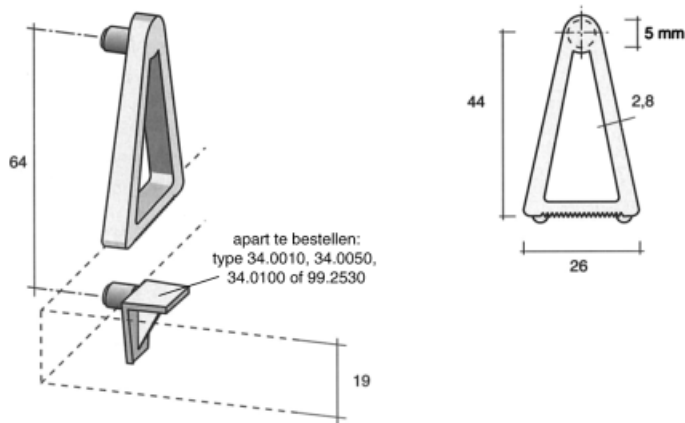

Schapkleem type 34.0970
- te gebruiken met schapdrager

Bestelnr.	Afwerking	-	Verpakking
013189	wit		3000

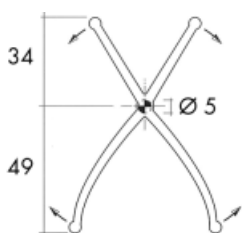

Schapkleem type 34.1870

Bestelnr.	Afwerking	-	Verpakking
013475	bruin		5000
013474	wit		5000

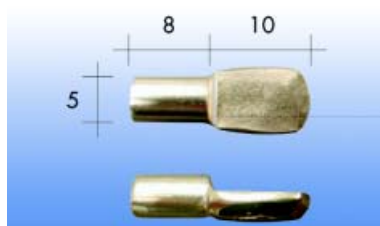

Schapdrager type 945

Bestelnr.	Afwerking	Diameter stift	Verpakking
010985	verkoperd	5 mm	2000
010986	vernikkeld	5 mm	2000

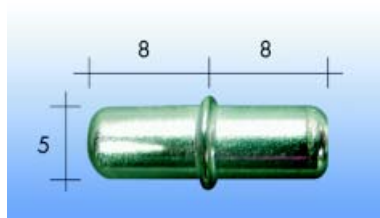

Schapdrager type 201.405.105

Bestelnr.	Afwerking	Diameter stift	Verpakking
012755	verzinkt	5 mm	6000

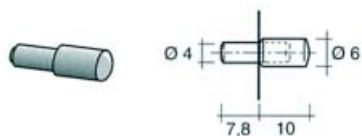

Schapdrager type 34.1670.1198

Bestelnr.	Afwerking	Diameter stift	Verpakking
013476	metaal/transparant	4 mm	1



Schapdrager type 1200

Bestelnr.	Afwerking	Diameter stift	Verpakking
010987	verkoperd	7 mm	2000
010988	vernikkeld	7 mm	1000

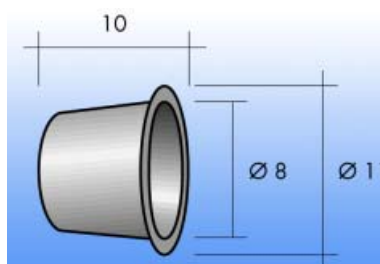

Huls voor schapdrager type 1200

- boren op 7,5 mm

Bestelnr.	Afwerking	Voor stift	Verpakking
010993	verkoperd	7 mm	1000
010994	vernikkeld	7 mm	1000

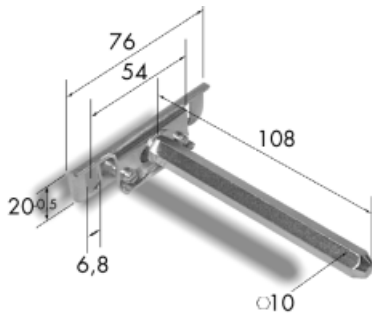

Regelbare schapdrager type 330005

- om in de legplank te boren
- 3-dimensionaal verstelbaar

Bestelnr.	Afwerking	-	Verpakking
013401	verzinkt	-	I

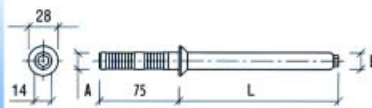

Schapdrager type 7019

- om in de legplank te boren

Bestelnr.	Afwerking	Boordiameter A	Lengte L	Diameter B	Verpakking
013402	verzinkt	12 mm	120 mm	12 mm	I
013403	verzinkt	16 mm	140 mm	14 mm	I

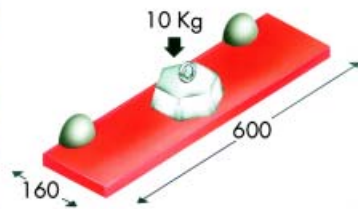
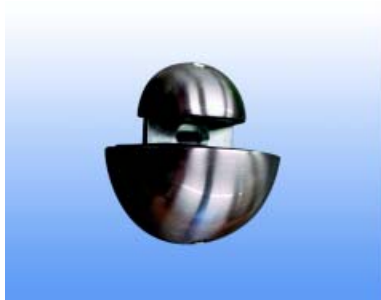

Schapdrager type Giotto

- de dragers kunnen na montage nog in de hoogte versteld worden zodat het legbord steeds horizontaal ligt
- traploos regelbaar: 3-10 mm (dikte legbord)
- per paar

Bestelnr.	Afwerking	Draagkracht	Voor legbord van maximum	Verpakking
021822	vernikkeld	10 KG	3 à 10 mm	20
021820	wit	10 KG	3 à 10 mm	20
021823	zilver	10 KG	3 à 10 mm	20
021821	zwart	10 KG	3 à 10 mm	20
021818	vernikkeld	18 KG	3 à 30 mm	20
021816	wit	18 KG	3 à 30 mm	20
021819	zilver	18 KG	3 à 30 mm	20
021817	zwart	18 KG	3 à 30 mm	20

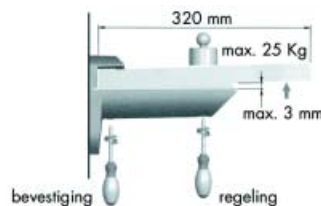
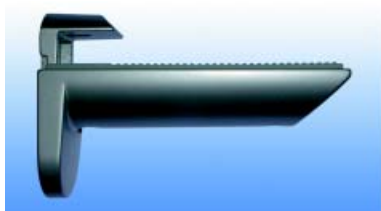

Schapdrager type Kaiman

- de drager kan na montage nog in de hoogte versteld worden zodat het legbord steeds horizontaal ligt
- per paar

Bestelnr.	Afwerking	Draagkracht	Dikte legbord	Verpakking
021987	aluminium	25 KG	8-40 mm	-
021988	alu /inox	25 KG	8-40 mm	-

Schapdrager type 2000M



Bestelnr.	Afwerking	Voor glas van	Verpakking
056928	goud	6 mm	40
056929	goud	8 mm	40
056930	goud	10 mm	40
056938	nikkel mat	6 mm	40
056939	nikkel mat	8 mm	40
056940	nikkel mat	10 mm	40

Schapdrager type 2001M

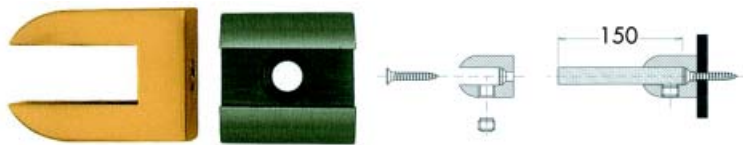

Bestelnr.	Afwerking	Voor glas van	Verpakking
056931	goud	6 mm	40
056932	goud	8 mm	40
056933	goud	10 mm	40
056941	nikkel mat	6 mm	40
056942	nikkel mat	8 mm	40
056943	nikkel mat	10 mm	40

Schapdrager type 2015

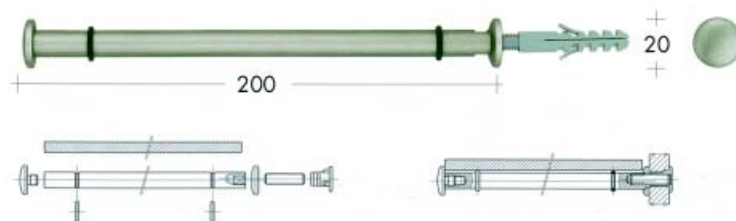

Bestelnr.	Afwerking	Lengte	Verpakking
056937	goud	200 mm	6
056944	nikkel mat	200 mm	6

SCHAPDRAGERS VOOR GLASPLATEN

Schapdrager type 38.0480/34.1260

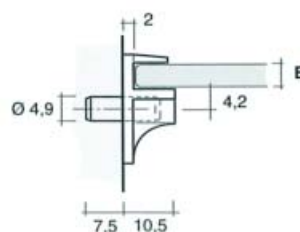
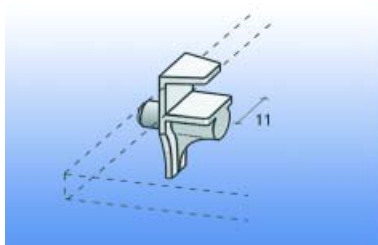

Bestelnr.	Afwerking	Type	Glasdikte B	Verpakking
013088	transparant	34.0480	4,5 mm	2000
013171	transparant	34.1260	6,35 mm	2000



Schapdrager type 630

- voor veiligheidsglas van 5 tot 10 mm dik

Bestelnr.	Afwerking	Afmeting	Verpakking
700611	chrom	15 x 15 mm	100
700610	koper	15 x 15 mm	100
700607	chrom	27 x 16 mm	4
700608	koper	27 x 16 mm	4



Schapdrager type 630 voor 5 mm rijboring

- voor veiligheidsglas van 5 tot 10 mm dik

Bestelnr.	Afwerking	Afmeting	Verpakking
700609	koper	27 x 16 mm	1

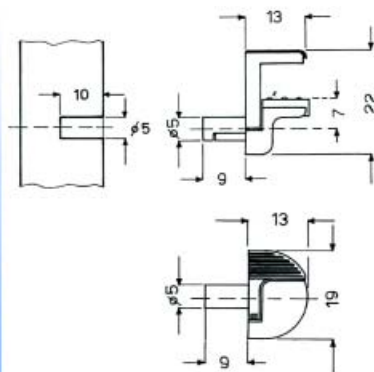

Schapdrager type Alfa

- voor glasdikte van 8 tot 12 mm

Bestelnr.	Afwerking	Diameter stift	Verpakking
013197	vernikkeld	5 mm	100
013198	zwart verzinkt	5 mm	100

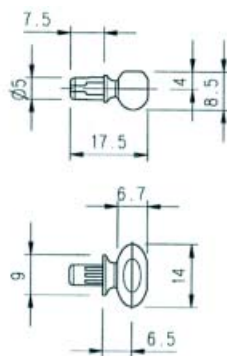

Schapdrager type 301 I

- per set van 4 stuks

Bestelnr.	Afwerking	Diameter stift	Verpakking
010997	vernikkeld	5 mm	1

SCHROEVEN

SCHROEVEN



Verbindingsschroef type 40.0301
- verbindingsschroef met metalen stift

Bestelnr.	Afwerking	Maat	Verpakking
001928	bruin	30-39 mm	1000
001929	bruin	36-45 mm	1000
001922	wit	30-39 mm	1000
001923	wit	36-45 mm	1000



Verbindingsschroef

Bestelnr.	Afwerking	Maat	Verpakking
003461	vernikkeld	van 30 tot 39 mm	1

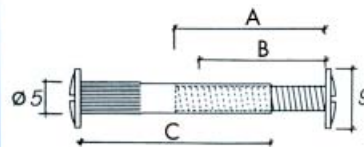

Verbindingsschroef

Bestelnr.	Afwerking	A	B	C	Verstelbaar van	Verpakking
003489	vernikkeld	15 mm	12 mm	31 mm	32 tot 40 mm	1
003488	vernikkeld	15 mm	12 mm	35 mm	37 tot 45 mm	1

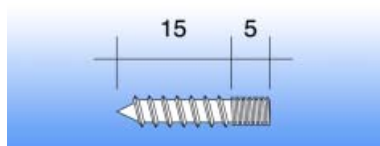

Boutstift type M4

Bestelnr.	Afwerking	-	Verpakking
003490	vernikkeld		1



Rugwandschroef
- schroef met zeer platte kop

Bestelnr.	Afwerking	Lengte	Verpakking
003494	vernikkeld	3 x 30 mm	1

**Schroef type M4**

- voor meubelknoppen en -grepen

Bestelnr.	Afwerking	Lengte	Verpakking
052269	verzinkt	10 mm	100
052271	verzinkt	15 mm	100
052273	verzinkt	20 mm	100
052274	verzinkt	21 mm	100
052275	verzinkt	22 mm	100
052276	verzinkt	23 mm	100
052277	verzinkt	25 mm	100
052278	verzinkt	28 mm	100
052279	verzinkt	30 mm	100
052280	verzinkt	35 mm	100
054506	verzinkt	38 mm	100
052282	verzinkt	40 mm	100
052283	verzinkt	43 mm	100
003487	verzinkt	50 mm	100
003499	verzinkt	60 mm	100



Schroef type pozidrive
- schroef met platte kop

Bestelnr.	Afwerking	Maat	Lengte	Verpakking
I01001	verzinkt	3 mm	12 mm	1000
I01002	verzinkt	3 mm	16 mm	1000
I01003	verzinkt	3 mm	20 mm	1000
I01004	verzinkt	3 mm	25 mm	1000
I01005	verzinkt	3 mm	30 mm	1000
I01006	verzinkt	3 mm	35 mm	1000
I01007	verzinkt	3,5 mm	12 mm	1000
I01008	verzinkt	3,5 mm	16 mm	1000
I01009	verzinkt	3,5 mm	20 mm	1000
I01010	verzinkt	3,5 mm	25 mm	1000
I01011	verzinkt	3,5 mm	30 mm	1000
I01012	verzinkt	3,5 mm	35 mm	1000
I01013	verzinkt	3,5 mm	35 mm	1000
003482	verzinkt	3,5 mm	45 mm	1000
003483	verzinkt	3,5 mm	50 mm	1000
I01014	verzinkt	4 mm	12 mm	1000
I01015	verzinkt	4 mm	16 mm	1000
I01016	verzinkt	4 mm	20 mm	1000
I01017	verzinkt	4 mm	25 mm	1000
I01018	verzinkt	4 mm	30 mm	1000
I01019	verzinkt	4 mm	35 mm	1000
I01020	verzinkt	4 mm	40 mm	1000
I01021	verzinkt	4 mm	45 mm	500
I01022	verzinkt	4 mm	50 mm	500
I01023	verzinkt	4,5 mm	16 mm	1000
I01024	verzinkt	4,5 mm	20 mm	1000
I01025	verzinkt	4,5 mm	25 mm	1000
I01026	verzinkt	4,5 mm	30 mm	1000
I01027	verzinkt	4,5 mm	35 mm	1000
I01028	verzinkt	4,5 mm	40 mm	500
I01029	verzinkt	4,5 mm	45 mm	500
I01030	verzinkt	4,5 mm	50 mm	500
I01031	verzinkt	4,5 mm	60 mm	500
I01032	verzinkt	5 mm	20 mm	1000
I01033	verzinkt	5 mm	25 mm	1000
I01034	verzinkt	5 mm	30 mm	1000
I01035	verzinkt	5 mm	35 mm	500
I01036	verzinkt	5 mm	40 mm	500
I01037	verzinkt	5 mm	45 mm	500
I01038	verzinkt	5 mm	50 mm	200
I01039	verzinkt	5 mm	60 mm	200
I01040	verzinkt	5 mm	70 mm	200
I01041	verzinkt	5 mm	80 mm	200
I01042	verzinkt	6 mm	40 mm	500
I01043	verzinkt	6 mm	50 mm	200
I01044	verzinkt	6 mm	60 mm	200
I01045	verzinkt	6 mm	70 mm	200
I01046	verzinkt	6 mm	80 mm	200
I01047	verzinkt	6 mm	90 mm	200
I01048	verzinkt	6 mm	100 mm	200



Schroef type pozidrive
- schroef met cilinder kop

Bestelnr.	Afwerking	Maat	Lengte	Verpakking
101049	verzinkt	3 mm	12 mm	1000
101050	verzinkt	3 mm	16 mm	1000
101051	verzinkt	3 mm	20 mm	1000
101052	verzinkt	3 mm	25 mm	1000
101053	verzinkt	3 mm	30 mm	1000
101054	verzinkt	3,5 mm	12 mm	1000
101055	verzinkt	3,5 mm	16 mm	1000
101056	verzinkt	3,5 mm	20 mm	1000
101057	verzinkt	3,5 mm	25 mm	1000
101058	verzinkt	3,5 mm	30 mm	1000
101059	verzinkt	3,5 mm	35 mm	1000
101060	verzinkt	4 mm	16 mm	1000
101061	verzinkt	4 mm	20 mm	1000
101062	verzinkt	4 mm	25 mm	1000
101063	verzinkt	4 mm	30 mm	1000
101064	verzinkt	4 mm	35 mm	1000
101065	verzinkt	4 mm	40 mm	1000
101066	verzinkt	4,5 mm	20 mm	1000
101067	verzinkt	4,5 mm	25 mm	1000
101068	verzinkt	4,5 mm	30 mm	1000
101069	verzinkt	4,5 mm	35 mm	1000
101070	verzinkt	4,5 mm	40 mm	500
101071	verzinkt	4,5 mm	45 mm	500
101072	verzinkt	5 mm	20 mm	1000
101073	verzinkt	5 mm	25 mm	1000
101074	verzinkt	5 mm	30 mm	1000
101075	verzinkt	5 mm	35 mm	500
101076	verzinkt	5 mm	40 mm	500
101077	verzinkt	5 mm	45 mm	500
101078	verzinkt	5 mm	50 mm	200
101079	verzinkt	6 mm	40 mm	500
101080	verzinkt	6 mm	50 mm	200
101081	verzinkt	6 mm	60 mm	200



Spaanplaat Schroef type pozidrive
- schroef met geboorde kop

Bestelnr.	Afwerking	Maat	Lengte	Verpakking
003473	verzinkt	4,5 mm	20 mm	1000
003474	verzinkt	4,5 mm	25 mm	1000
003475	verzinkt	4,5 mm	30 mm	1000
003476	verzinkt	4,5 mm	35 mm	500
003477	verzinkt	4,5 mm	40 mm	500
003478	verzinkt	4,5 mm	45 mm	500
003479	verzinkt	4,5 mm	50 mm	500
003480	verzinkt	4,5 mm	55 mm	500
003481	verzinkt	4,5 mm	60 mm	500

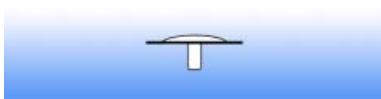

Afdekkapjes voor spaanplaatschroef
- voor spaanplaatschroeven met geboorde kop

Bestelnr.	Afwerking	Afmetingen	Verpakking
003470	beige	2,5 mm	1000
003468	bruin	2,5 mm	1000
003471	licht grijs	2,5 mm	1000
003491	donker grijs	2,5 mm	1000
003467	wit	2,5 mm	1000
003469	zwart	2,5 mm	1000



Parkerschroef type DIN.7971.CK

Bestelnr.	Afwerking	Afmetingen	Verpakking
100526	verzinkt	3,5 x 25 mm	1000
100527	verzinkt	3,9 x 25 mm	1000



Schroef type Conformat
- schroef voor meubelmontage
- zelftappend

Bestelnr.	Afwerking	Afmetingen	Verpakking
010861	verzinkt	7 x 50 mm	1000



Schroefhaak type 7

Bestelnr.	Afwerking	Afmetingen	Verpakking
001171	verzinkt	30 mm	100
001172	verzinkt	40 mm	100
001173	verzinkt	50 mm	100
001175	verzinkt	40 mm	100
001176	verzinkt	50 mm	100
001177	verzinkt	65 mm	100
001178	verzinkt	80 mm	100
001179	verzinkt	100 mm	100



Vensterhaak type 26

Bestelnr.	Afwerking	Lengte	Diameter	Verpakking
001319	verzinkt	60 mm	5,8 mm	100

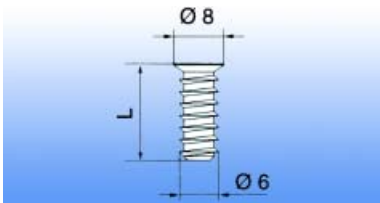

Schroef euro Grass

Bestelnr.	Afwerking	Lengte L	Verpakking
030996	vernikkeld	8,5 mm	100
028993	vernikkeld	11,5 mm	100
028994	vernikkeld	13 mm	100
028995	vernikkeld	14,5 mm	100
028996	vernikkeld	17 mm	100
028997	vernikkeld	22 mm	100

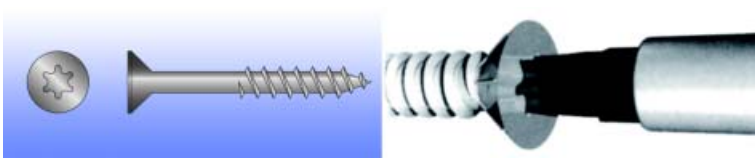

TX-schroeven

- door de speciale kopboring van TX-schroeven zet een bit of schroevendraaier zich steviger vast wat het vastschroeven aanzienlijk vereenvoudigt
- TX-schroeven van 16 en 20 mm zijn niet voorzien van een klemlengte, de overige wel
- door de klemlengte trekken de onderdelen steviger aan

Bestelnr.	Afwerking	Lengte	Diameter	Klemlengte	Verpakking
003501	geel verzinkt	16 mm	3,5 mm	-	200
003505	geel verzinkt	16 mm	4 mm	-	200
003502	geel verzinkt	20 mm	3,5 mm	-	200
003506	geel verzinkt	20 mm	4 mm	-	200
003503	geel verzinkt	25 mm	3,5 mm	7 mm	200
003507	geel verzinkt	25 mm	4 mm	7 mm	200
003504	geel verzinkt	30 mm	3,5 mm	12 mm	200
003508	geel verzinkt	30 mm	4 mm	12 mm	200
003522	geel verzinkt	35 mm	3,5 mm	11 mm	200
003509	geel verzinkt	35 mm	4 mm	11 mm	200
003511	geel verzinkt	35 mm	4,5 mm	11 mm	200
003523	geel verzinkt	40 mm	3,5 mm	16 mm	200
003510	geel verzinkt	40 mm	4 mm	16 mm	200
003512	geel verzinkt	40 mm	4,5 mm	16 mm	200
003524	geel verzinkt	50 mm	3,5 mm	20 mm	200
003527	geel verzinkt	50 mm	4 mm	20 mm	200
003513	geel verzinkt	50 mm	4,5 mm	20 mm	200
003514	geel verzinkt	50 mm	5 mm	20 mm	200
003525	geel verzinkt	60 mm	3,5 mm	24 mm	200
003515	geel verzinkt	60 mm	5 mm	24 mm	200

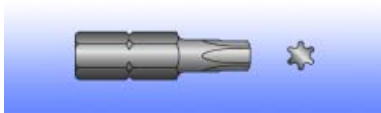

TX-bits voor TX-schroeven

Bestelnr.	Afwerking	Type	Voor TX-schroeven met Ø	Verpakking
003516	-	T15	3,5 mm	I
003517	-	T20	4 mm	I
003518	-	T25	4,5 en 5 mm	I

MOEREN

MOEREN



Inslagmoer type Fantasia
- inslagmoer met 4 pinnen

Bestelnr.	Afwerking	Maat	Verpakking
001891	staal	M6	I
001892	staal	M8	I
001893	staal	M10	I



Inslagmoer type Rampa

Bestelnr.	Afwerking	Binnendraad	Maat	Verpakking
003460	koper	M4	8 x 8 mm	I
002016	staal	M3	6 x 8 mm	I
002019	staal	M4	8 x 8 mm	I
002023	staal	M5	10x12 mm	I
002024	staal	M5	10x15 mm	I
002029	staal	M6	12x12 mm	I

SLOTEN

SLEUTELS EN CILINDERS BMB MODUL 1000 SYSTEEM

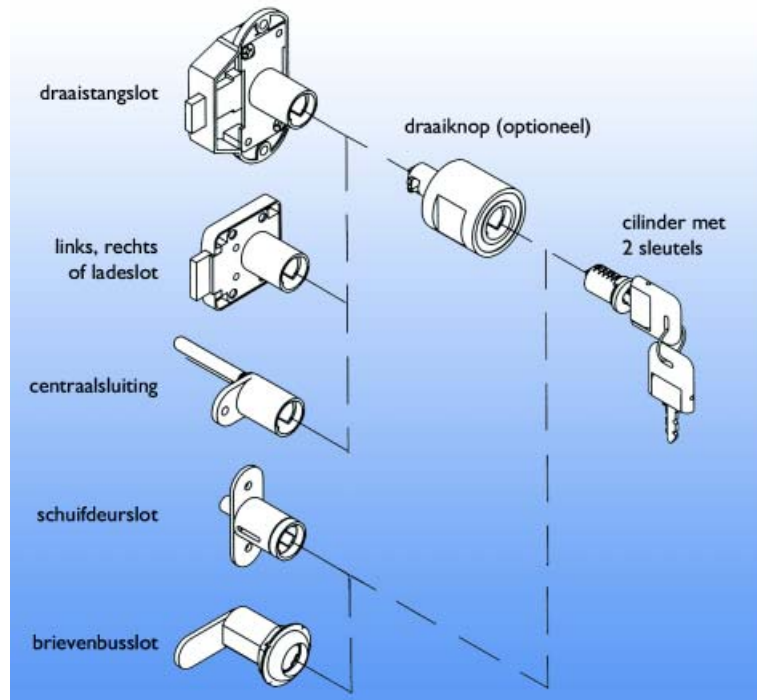

Installatie van de cilinder

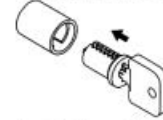

De cilinder inbrengen met de montagesleutel in het open slot.

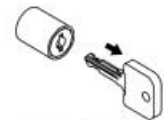

De montagesleutel verwijderen om de cilinder vast te zetten.

Demontage van de cilinder

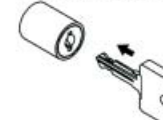

De montagesleutel in de cilinder steken (open slot).

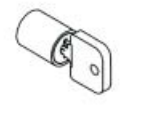

De cilinder wordt ontgrendeld.



De cilinder d.m.v. de montagesleutel verwijderen.



Montagesleutel

- Om de cilinder in het slot te plaatsen dient u gebruik te maken van een montagesleutel (slot in open stand).
- De montagesleutel is voor alle series dezelfde, d.w.z. dat u aan 1 montagesleutel voldoende hebt om cilinders uit verschillende series te monteren.
- Deze sleutel dient u apart te bestellen.

Bestelnr.	Afwerking	-	Verpakking
013257	gele kap	-	100

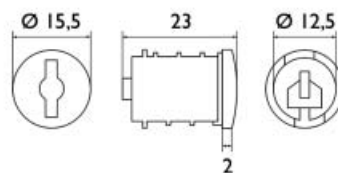

Cilinders verschillend sluitende series

- cilinder met 2 sleutels

Bestelnr.	Afwerking	Omschrijving	Verpakking
013246	vernikkeld	sluiting A001-A200	100
013432	vernikkeld	sluiting A201-A400	100
013433	vernikkeld	sluiting A401-A600	100



Hoofdsleutel voor verschillend sluitende series
- kan alle cilinders van 1 reeks openen

Bestelnr.	Afwerking	Omschrijving	Verpakking
013250	rode kap	MKA1, opent sluiting A001-A200	100
013424	rode kap	MKA1, opent sluiting A201-A400	100
013425	rode kap	MKA1, opent sluiting A401-A600	100



Meestersleutel
- kan alle cilinders van alle reeksen openen

Bestelnr.	Afwerking	Omschrijving	Verpakking
013426	vernikkeld	opent alle cilinders van alle reeksen	1

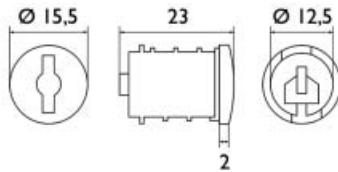

Gelijksluitende series
- cilinder met 2 sleutels

Bestelnr.	Afwerking	Omschrijving	Verpakking
013247	vernikkeld	serie 1, cilinder met 2 sleutels	1
013248	vernikkeld	serie 2, cilinder met 2 sleutels	1
013249	vernikkeld	serie 3, cilinder met 2 sleutels	1
013437	vernikkeld	serie 4, cilinder met 2 sleutels	1
013438	vernikkeld	serie 5, cilinder met 2 sleutels	1
013439	vernikkeld	serie 6, cilinder met 2 sleutels	1
013440	vernikkeld	serie 7, cilinder met 2 sleutels	1
013441	vernikkeld	serie 8, cilinder met 2 sleutels	1
013442	vernikkeld	serie 9, cilinder met 2 sleutels	1
013443	vernikkeld	serie 10, cilinder met 2 sleutels	1
013454	vernikkeld	serie 11, cilinder met 2 sleutels	1
013455	vernikkeld	serie 12, cilinder met 2 sleutels	1
013456	vernikkeld	serie 13, cilinder met 2 sleutels	1
013457	vernikkeld	serie 14, cilinder met 2 sleutels	1
013458	vernikkeld	serie 15, cilinder met 2 sleutels	1
013459	vernikkeld	serie 16, cilinder met 2 sleutels	1
013460	vernikkeld	serie 17, cilinder met 2 sleutels	1
013461	vernikkeld	serie 18, cilinder met 2 sleutels	1
013462	vernikkeld	serie 19, cilinder met 2 sleutels	1
013463	vernikkeld	serie 20, cilinder met 2 sleutels	1
013464	vernikkeld	serie 21, cilinder met 2 sleutels	1
013465	vernikkeld	serie 22, cilinder met 2 sleutels	1
013466	vernikkeld	serie 23, cilinder met 2 sleutels	1
013467	vernikkeld	serie 24, cilinder met 2 sleutels	1
013468	vernikkeld	serie 25, cilinder met 2 sleutels	1
013469	vernikkeld	serie 26, cilinder met 2 sleutels	1
013470	vernikkeld	serie 27, cilinder met 2 sleutels	1
013471	vernikkeld	serie 28, cilinder met 2 sleutels	1
013472	vernikkeld	serie 29, cilinder met 2 sleutels	1
013473	vernikkeld	serie 30, cilinder met 2 sleutels	1

Rosace voor sloten

Bestelnr.	Afwerking	-	Verpakking
013436	vernikkeld		1

SLOTEN MODUL 1000 SYSTEEM

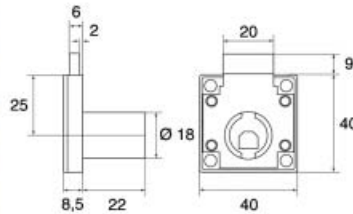
**Ladeslot type 1061.100**

- u dient de cilinder voor alle sloten apart te bestellen

Bestelnr.	Afwerking	-	Verpakking
013258	vernikkeld		20

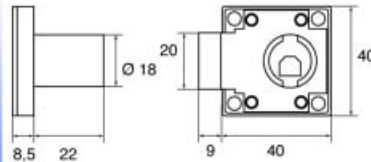
**Ladeslot type 1061.000**

- links of rechts te gebruiken
- u dient de cilinder voor alle sloten apart te bestellen

Bestelnr.	Afwerking	-	Verpakking
013490	vernikkeld		100

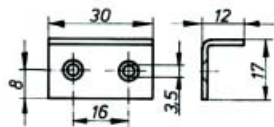
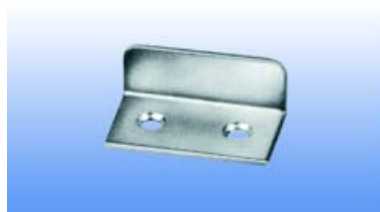
**Aanslag type K voor slot type 1061**

Bestelnr.	Afwerking	-	Verpakking
011928	vernikkeld		1000

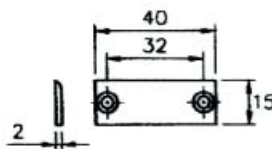
**Afstandhouder type 1503 voor slot type 1061**

Bestelnr.	Afwerking	-	Verpakking
013483	zwart		100

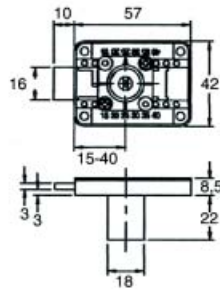

Slot type 123 I

- u dient de cilinder voor alle sloten apart te bestellen
- links/rechts omkeerbaar
- ook bruikbaar als ladeslot

Bestelnr.	Afwerking	Omschrijving	Verpakking
013477	vernikkeld	links/rechts omkeerbaar	100

Aanslag type K voor slot type 123 I

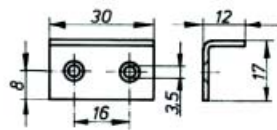
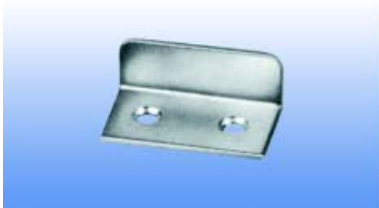

Bestelnr.	Afwerking	-	Verpakking
011928	vernikkeld		1000

Afstandhouder type 1503 voor slot type 123 I

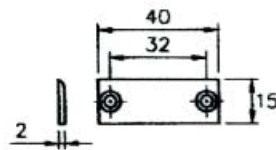

Bestelnr.	Afwerking	-	Verpakking
013483	zwart		100

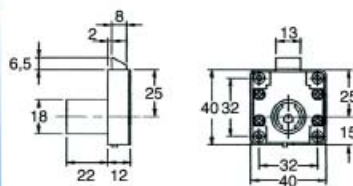

Ladeslot type 115 I

- u dient de cilinder voor alle sloten apart te bestellen
- de schieter vergrendelt bij het sluiten van de lade

Bestelnr.	Afwerking	-	Verpakking
013478			

Aanslag type K voor slot type 115 I

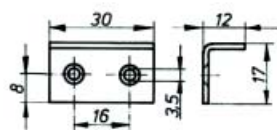
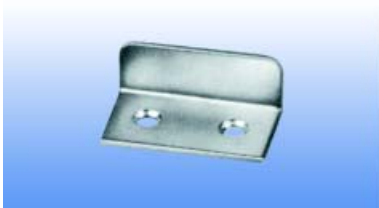

Bestelnr.	Afwerking	-	Verpakking
011928	vernikkeld		1000

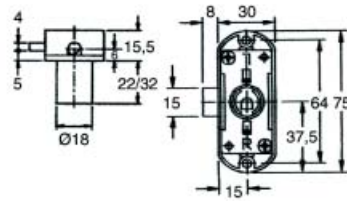
**Draaistangslot type 1301**

- u dient de cilinder voor alle sloten apart te bestellen
- doornmaat: 15 mm
- links/rechts omkeerbaar

Bestelnr.	Afwerking	Omschrijving	Verpakking
013479	vernikkeld	links/rechts omkeerbaar	100

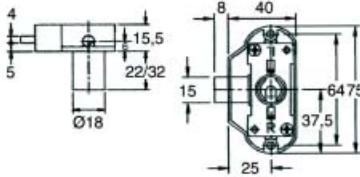
**Draaistangslot type 1371**

- u dient de cilinder voor alle sloten apart te bestellen
- doornmaat: 25 mm
- links/rechts omkeerbaar

Bestelnr.	Afwerking	Omschrijving	Verpakking
013480	vernikkeld	links/rechts omkeerbaar	100

**Garnituur voor draaistangslot**

- garnituur bestaat uit:
 - 2 sluithaken
 - 2 stanghouders
 - 1 aanslagplaat
 - 2 sluitstiften

Bestelnr.	Afwerking	Omschrijving	Verpakking
013263	vernikkeld	-	100

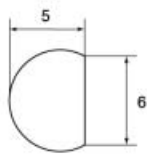

Stang voor draaistangslot

- per slot hebt u 2 stangen nodig

Bestelnr.	Afwerking	Lengte	Verpakking
013274	vernikkeld	1500 mm	1

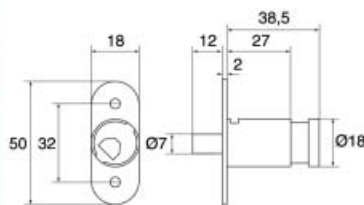
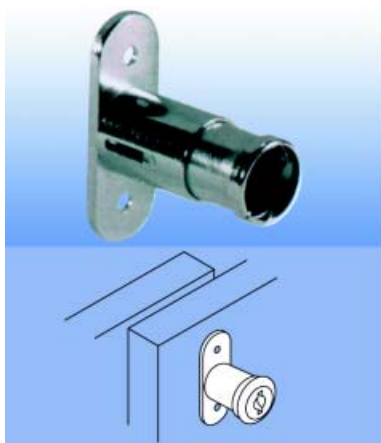

Schuifdeurslot type 1111

- u dient de cilinder voor alle sloten apart te bestellen
 - de cilinder dient op 45° ingebouwd te worden
 - u kan geen draaiknop gebruiken bij dit slot

Bestelnr.	Afwerking	-	Verpakking
013268	vernikkeld		100

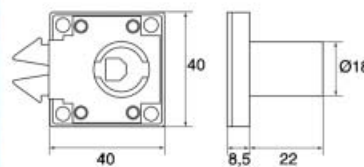

Schuifdeurslot type 1051

- u dient de cilinder voor alle sloten apart te bestellen

Bestelnr.	Afwerking	-	Verpakking
013275	vernikkeld		20

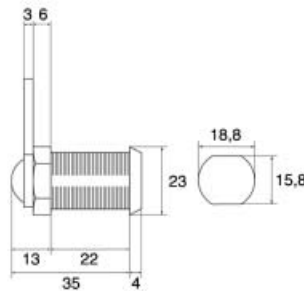
**Brievenslot type 100**

- u dient de cilinder voor alle sloten apart te bestellen
- rechts brievenbuslot

Bestelnr.	Afwerking	-	Verpakking
013269	vernikkeld		20

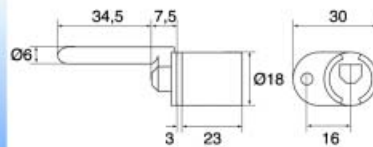
**Centraalsluiting type 1181**

- u dient de cilinder voor alle sloten apart te bestellen
- centraalsluiting met 1 vleugel

Bestelnr.	Afwerking	-	Verpakking
013264	vernikkeld		20

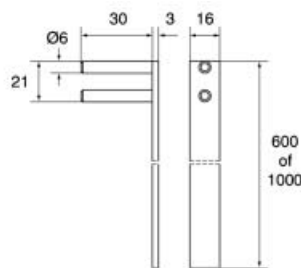
**Stang type 1210 voor centraalsluiting**

Bestelnr.	Afwerking	Lengte	Verpakking
013265	aluminium	600 mm	20
013276	aluminium	1000 mm	20

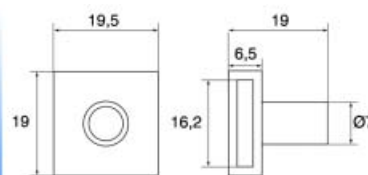
**Sluitstift type 1212.100 voor centraalsluiting**

Bestelnr.	Afwerking	-	Verpakking
013266	vernikkeld		60

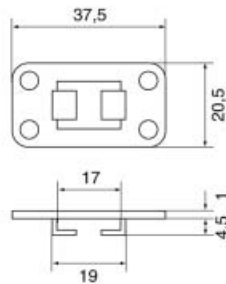
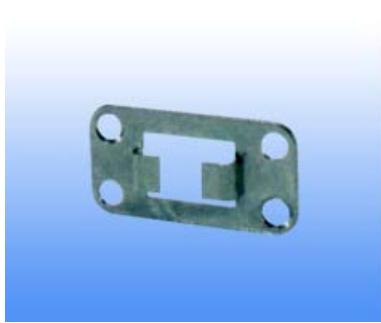

Stanghouder type 1212.200 voor centraalsluiting

Bestelnr.	Afwerking	-	Verpakking
013267	vernikkeld		40

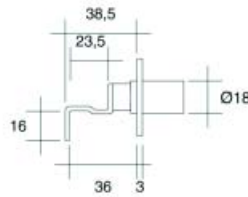

Rolluikslot type 1161

Bestelnr.	Afwerking	-	Verpakking
013411	vernikkeld		20

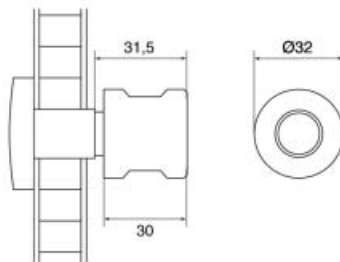
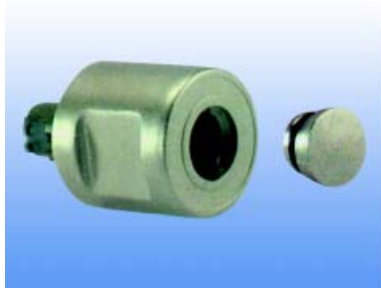

Draaiknop type 1401

- u dient de cilinder voor alle sloten apart te bestellen
- De draaiknop wordt standaard geleverd met een afdekkap (voor het geval u geen cilinder wil plaatsen), een demontagestift en een verdikplaatje (deurdikte > 19 mm).

Bestelnr.	Afwerking	Links/rechts	Verpakking
013254	vernikkeld	links	100
013255	vernikkeld	rechts	100



Bevestiging type 1421 voor draaiknop

- Bevestiging voor draaiknop type 1401 en 1403 wanneer de knop zonder slot wordt gebruikt.

Bestelnr.	Afwerking	-	Verpakking
013256	vernikkeld		100

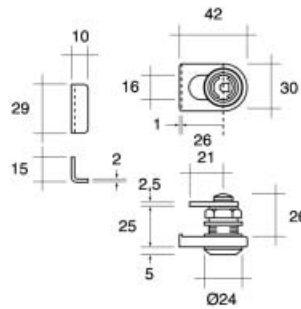
**Glasdeurslot type 1251**

- u dient de cilinder voor alle sloten apart te bestellen

Bestelnr.	Afwerking	Voor glasdikte	Verpakking
013245	vernikkeld	4-10 mm	20

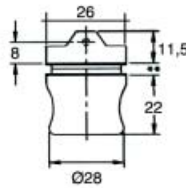
**Glasdeurslot type 1281**

- u dient de cilinder voor alle sloten apart te bestellen
 - zelfde boring als bij Salice scharnieren: Ø 26 mm

Bestelnr.	Afwerking	Voor glasdikte	Lengte van de stift	Verpakking
013481	vernikkeld	4-8 mm	9 mm	100

**Automatische deurgrendel type 1481**

- voor dubbele deuren
 - toepassing met I slot
 - set voor boven en onder

Bestelnr.	Afwerking	-	Verpakking
013482	vernikkeld		100

SLOT TYPE MODUL 1000 VOOR ENKELE GLASDEUREN

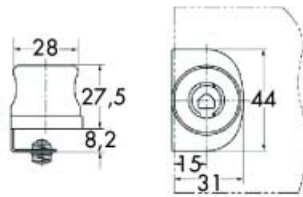

Slot type Modul 1000 voor enkele deur

- het slot wordt d.m.v. schroeven met nylon kop op het glas vastgeklemd
- voor glasdikte 4-6 mm

Bestelnr.	Afwerking	Links of rechts slot	Voor glasdikte	Verpakking
013582	vernikkeld	rechts	4-6 mm	10
013584	vernikkeld	links	4-6 mm	10

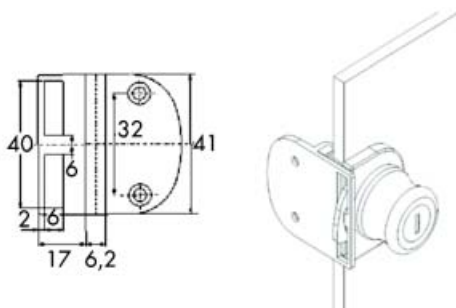

Sluitstuk voor slot type Modul 1000

- voorzien van rubberen demper
- te schroeven

Bestelnr.	Afwerking			Verpakking
013586	vernikkeld	-	-	1

SLOT TYPE MODUL 1000 VOOR DUBBELE GLASDEUREN

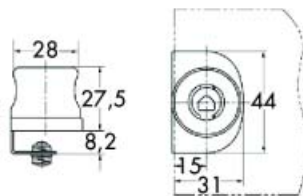

Slot type Modul 1000 voor dubbele deur

- het slot wordt d.m.v. schroeven met nylon kop op het glas vastgeklemd
- voor glasdikte 4-6 mm

Bestelnr.	Afwerking	Links of rechts slot	Voor glasdikte	Verpakking
013582	vernikkeld	rechts	4-6 mm	10

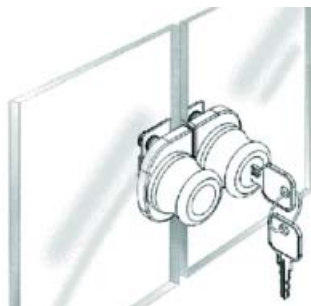

Tegenstuk voor slot type Modul 1000

- het tegenstuk wordt d.m.v. schroeven met nylon kop op het glas vastgeklemd
- voor glasdikte 4-6 mm

Bestelnr.	Afwerking			Verpakking
013583	vernikkeld	-	-	10

SLOT TYPE MODUL 1000 VOOR GLASSCHUIFDEUREN

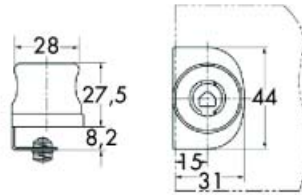
**Slot type Modul 1000 voor schuifdeuren**

- het slot wordt d.m.v. schroeven met nylon kop op het glas vastgeklemd
- voor glasdikte 4-6 mm

Bestelnr.	Afwerking	Links of rechts slot	Voor glasdikte	Verpakking
013582	vernikkeld	rechts	4-6 mm	10
013584	vernikkeld	links	4-6 mm	10

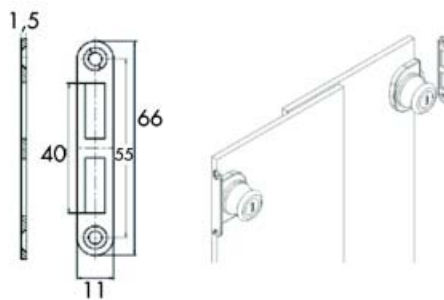
**Sluitplaat voor slot type Modul 1000**

- te schroeven

Bestelnr.	Afwerking	-	Verpakking
013587	vernikkeld	-	1

GLASDEURKNOP TYPE MODUL 1000

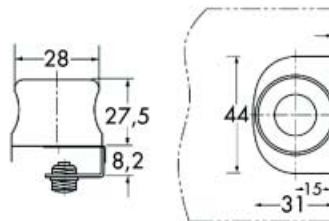
**Glasdeurknop type Modul 1000**

- voor deur met scharnieren of glasschuifdeuren
- links en rechts te gebruiken
- voor glasdikte 4-6 mm

Bestelnr.	Afwerking	Voor glasdikte	Verpakking
013585	vernikkeld	4-6 mm	1

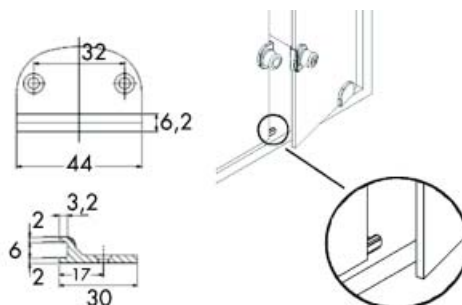
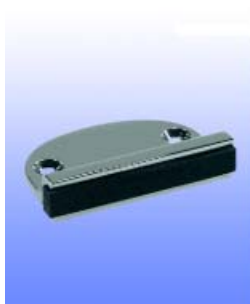
**Aanslag voor glasdeuren**

- voorzien van rubberen demper
- te schroeven

Bestelnr.	Afwerking	-	Verpakking
013588	vernikkeld	-	1

GLASDEURSCHARNIEREN TYPE MODUL 1000



Zelfsluitende glasdeurscharnier type Modul 1000

- voor glasdikte 4-6 mm
- per stuk

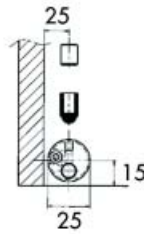
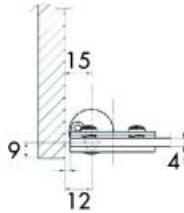
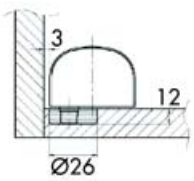

Bestelnr.	Afwerking	Openingshoek	Plaatsing	Voor glasdikte	Verpakking
013589	vernikkeld	105°	linksboven/rechtsonder	4-6 mm	I
013590	vernikkeld	105°	rechtsboven/linksonder	4-6 mm	I

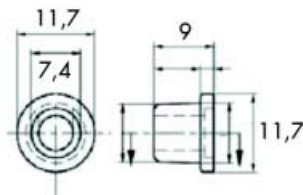

Glasdeurscharnier type Modul 1000

- voor glasdikte 4-6 mm
- per stuk

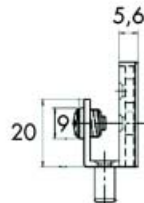
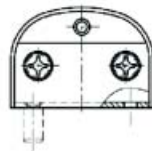
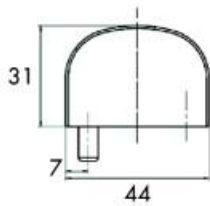

Bestelnr.	Afwerking	Plaatsing	Voor glasdikte	Verpakking
013591	vernikkeld	linksboven/rechtsonder	4-6 mm	I
013592	vernikkeld	rechtsboven/linksonder	4-6 mm	I

ANSELMI DRAAISTANGSLOTEN

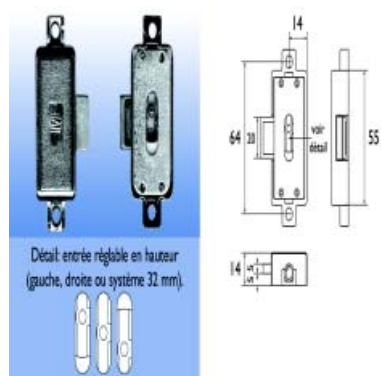
**Draaistangslot type 650**

- links/rechts omkeerbaar
- de sleutelingang is in de hoogte verstelbaar
- entree: 25 mm

Bestelnr.	Afwerking	-	Verpakking
013270	vernikkeld		10

**Garnituur voor draaistangslot type 145 I**

Garnituur bestaat uit:

- 2 sluithaken
- 2 stanghouders
- 1 aanslagplaat
- 2 sluitstiften

Bestelnr.	Afwerking	-	Verpakking
013263	vernikkeld		100

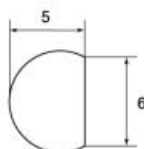
**Stang voor draaistangslot type 145 I**

- per slot heeft u 2 stangen nodig

Bestelnr.	Afwerking	Lengte	Verpakking
013274	vernikkeld	1500 mm	1



Sleutel type 16 voor Anselmi draaistangslot
- passend voor Anselmi draaistangslot

Bestelnr.	Afwerking	Lengte	Verpakking
056567	brons antiek	40 mm	50



Sleutel type 26 voor Anselmi draaistangslot
- passend voor Anselmi draaistangslot

Bestelnr.	Afwerking	Lengte	Verpakking
056570	brons antiek	35 mm	50

AANSLAGEN VOOR SLOTEN

Aanslag type K

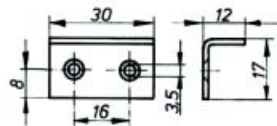

Bestelnr.	Afwerking	-	Verpakking
011928	vernikkeld		1000

KASTGRENDEL

KASTGRENDEL

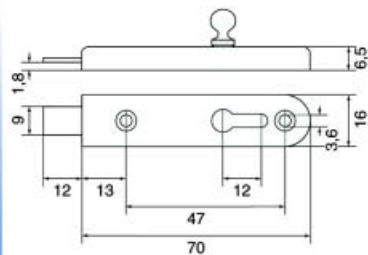

Kastgrendel type 373F-NIP

Bestelnr.	Afwerking	-	Verpakking
010792	vernikkeld		250

KASTSLUITINGEN

KASTSLUITINGEN

Kastsluiting type 215

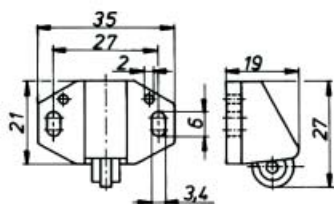

Bestelnr.	Afwerking	-	Verpakking
010460	bruin		250
010459	wit		250

Aanslag type AA

- voor kastsluiting type 215

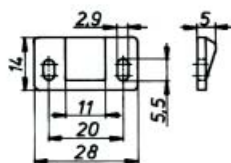
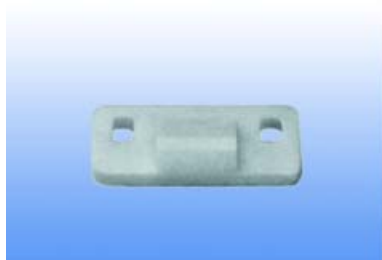

Bestelnr.	Afwerking	-	Verpakking
010462	bruin		1000
010461	wit		1000

Kastsluiting type Ideal

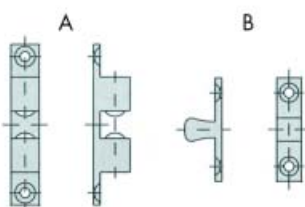

Bestelnr.	Afwerking	Lengte A	Boorafstand A	Lengte B	Boorafstand B	Verpakking
012169	koper	34 mm	37 mm	25 mm	19 mm	100
012170	koper	50 mm	42 mm	28 mm	20 mm	100
012171	koper	60 mm	52 mm	39 mm	27 mm	50
012172	koper	70 mm	58 mm	42 mm	32 mm	50

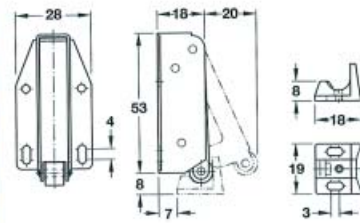

Kastsluiting type Quick Latch

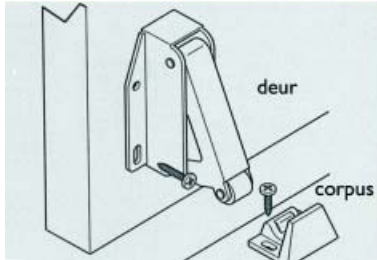

Bestelnr.	Afwerking	-	Verpakking
012176	staal/kunststof wit	-	1

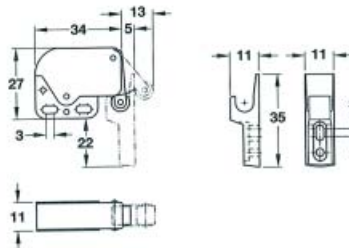
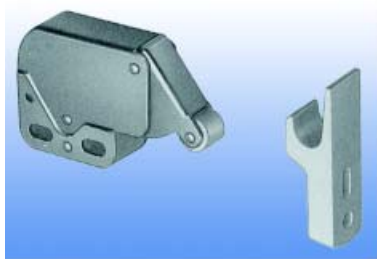

Kastsluiting type Mini Latch

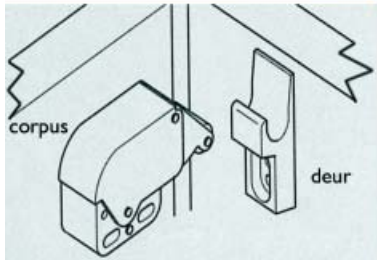

Bestelnr.	Afwerking	-	Verpakking
012175	staal vernikkeld/kunststof wit	-	1



Kastsluiting type Clips chip

Bestelnr.	Afwerking	-	Verpakking
012986	ijzer/nikkel	-	100

DUWSPRINGSLOT

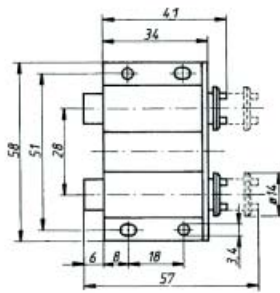
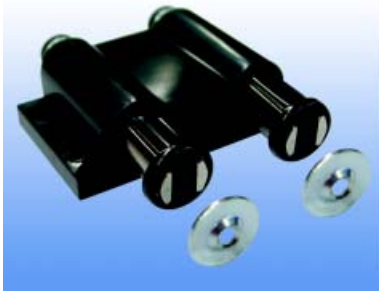

Duwspringslot type 283
- rondel apart te bestellen

Bestelnr.	Afwerking	Omschrijving	Verpakking
013166	zwart	enkel duwspringslot	1
013435	zwart	dubbel duwspringslot	50
013489	-	rondel voor dubbel duwspringslot	1

DEURRECHTER

DEURRECHTER

Deurrechter type 0015-20

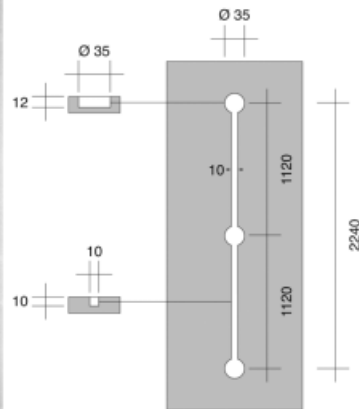
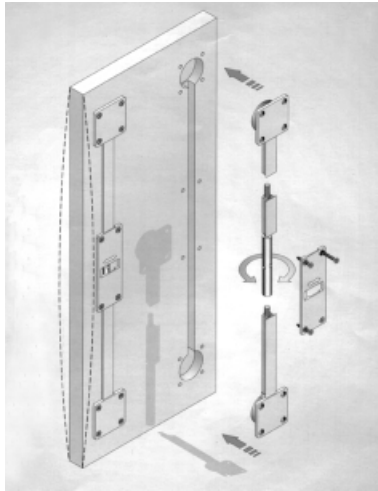

Bestelnr.	Afwerking	-	Verpakking
030526	aluminium/zwart	-	20

STELLIJSTEN

STELLIJSTEN

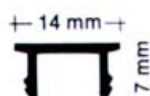
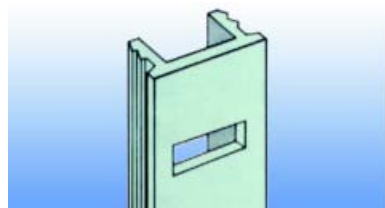

Stellijst type Vogue 7010

- afstand tussen de gaten: 25 mm (center/center)

Bestelnr.	Afwerking	Type	Lengte	Breedte	Diepte	Verpakking
011991	aluminium	inbouw	5000 mm	14 mm	7 mm	5

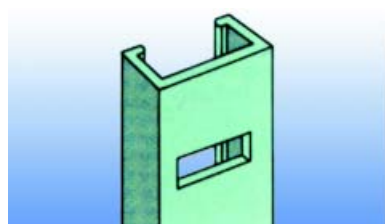

Stellijst type Vogue 7000

- afstand tussen de gaten: 25 mm (center/center)

Bestelnr.	Afwerking	Type	Lengte	Breedte	Diepte	Verpakking
011990	aluminium	opbouw	5000 mm	14 mm	7 mm	5

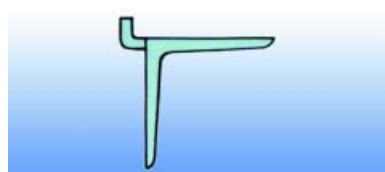

Draaghaak type 7018

- voor stellijsten Vogue

Bestelnr.	Afwerking	Type	Lengte	Breedte	Diepte	Verpakking
011992	aluminium	-	-	-	-	100



Stellijst type 8900

- afstand tussen de gaten: 14 mm (center/center)

Bestelnr.	Afwerking	Type	Lengte	Breedte	Diepte	Verpakking
011106	verkoperd	opbouw	2000 mm	16 mm	5 mm	1
011105	vernikkeld	opbouw	2000 mm	16 mm	5 mm	1



Draaghaak type 8901

- voor stellijst type 8900

Bestelnr.	Afwerking	Type	Lengte	Breedte	Diepte	Verpakking
011108	verkoperd	-	-	-	-	1
011107	vernikkeld	-	-	-	-	1

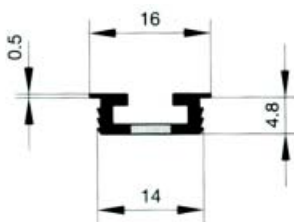

Stellijst type 660011

- afstand tussen de gaten: 15 mm (center/center)

Bestelnr.	Afwerking	Type	Lengte	Breedte	Diepte	Verpakking
011094	bruin	5300	5000 mm	14 mm	5,7 mm	I
011093	wit	5300	5000 mm	14 mm	5,7 mm	I

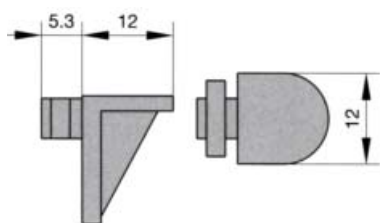

Draaghaak type 100070

- voor stellijst type 660011

Bestelnr.	Afwerking	Type	Lengte	Breedte	Diepte	Verpakking
011098	bruin	-	-	-	-	I
011097	wit	-	-	-	-	I



Stellijst type Rox

- afstand tussen de draagvlakken: 36 mm

Bestelnr.	Afwerking	Type	Lengte	Breedte	Diepte	Verpakking
011123	beuk	ROX	2000 mm	14 mm	14 mm	I

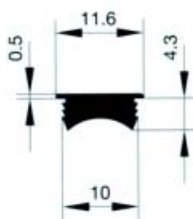
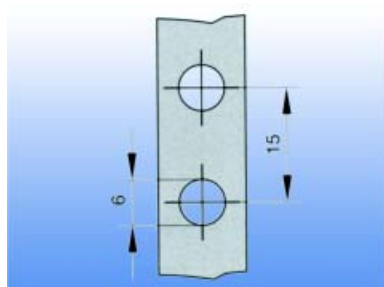

Stellijst type 660002

- afstand tussen de gaten: 15 mm (center/center)

Bestelnr.	Afwerking	Type	Lengte	Breedte	Diepte	Verpakking
011091	wit	10128	5000 mm	10 mm	4,5 mm	I

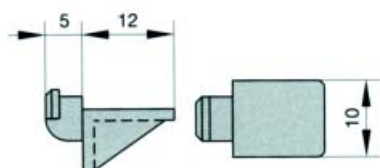

Draaghaak type 100080

- voor stellijst type 660002

Bestelnr.	Afwerking	Type	Lengte	Breedte	Diepte	Verpakking
011095	wit	-	-	-	-	I

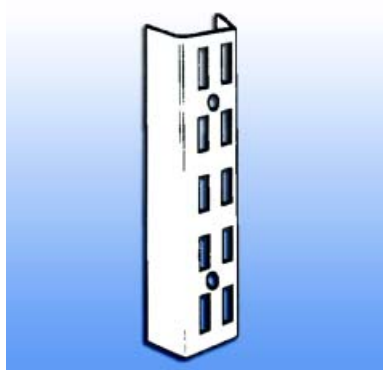

Stellijst type Sovella

- afstand tussen de gaten: 12 mm

Bestelnr.	Afwerking	Type	Lengte	Breedte	Diepte	Verpakking
011215	wit	Sovella	150 mm	32 mm	15 mm	10
011217	wit	Sovella	500 mm	32 mm	15 mm	10
011219	wit	Sovella	1000 mm	32 mm	15 mm	10
011221	wit	Sovella	1500 mm	32 mm	15 mm	10
011223	wit	Sovella	2000 mm	32 mm	15 mm	10
011225	wit	Sovella	2500 mm	32 mm	15 mm	10

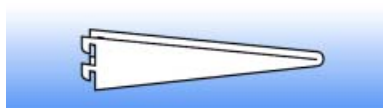

Dubbele draaghaak type Sovella I

- voor stellijst type Sovella

Bestelnr.	Afwerking	Lengte	Draagkracht	Verpakking
011227	wit	150 mm	120 KG	20
011229	wit	200 mm	100 KG	20
011231	wit	250 mm	80 KG	20
011233	wit	300 mm	70 KG	20
011235	wit	350 mm	60 KG	20

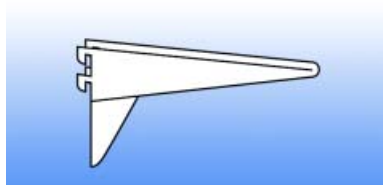

Dubbele draaghaak type Sovella 2

- voor stellijst type Sovella

Bestelnr.	Afwerking	Lengte	Draagkracht	Verpakking
011237	wit	400 mm	120 KG	20
011239	wit	450 mm	100 KG	20
011241	wit	500 mm	80 KG	20
011243	wit	550 mm	60 KG	20

STOELDOPPEN EN -GELEIDERS

STOELDOPPEN



Stoeldop type K

Bestelnr.	Afwerking	Diameter	Verpakking
020615	zwart	6 mm	1000
020616	zwart	8 mm	500
020617	zwart	10 mm	1000
020618	zwart	12 mm	500
020619	zwart	13 mm	1000
020620	zwart	14 mm	500
020621	zwart	15 mm	500
020622	zwart	16 mm	500
020623	zwart	18 mm	500
020624	zwart	19 mm	500
020625	zwart	20 mm	500
020626	zwart	21 mm	500
020627	zwart	22 mm	500
020628	zwart	24 mm	500
020629	zwart	25 mm	500
020646	zwart	27 mm	500
020630	zwart	28 mm	500
020631	zwart	30 mm	500
020632	zwart	32 mm	500
020633	zwart	34 mm	500
020650	zwart	35 mm	500
020634	zwart	38 mm	500
020635	zwart	40 mm	500
020636	zwart	42 mm	500
020638	zwart	45 mm	500
020639	zwart	47 mm	500
020640	zwart	49 mm	500
020643	zwart	59 mm	100
020648	zwart	63 mm	100



Stoeldop type KSG

Bestelnr.	Afwerking	Lengte	Breedte	Verpakking
020859	zwart	30 mm	18 mm	500
020862	zwart	42 mm	27 mm	500

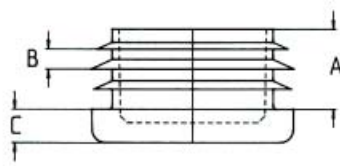

Vierkante stoeldop type VL

Bestelnr.	Afwerking	Oppervlak	A	B	C	Verpakking
020669	zwart	10x10 mm	11,5 mm	3 mm	4 mm	1000
020676	zwart	15x15 mm	11,5 mm	3 mm	4 mm	1000
020677	zwart	16x16 mm	11,5 mm	3 mm	5 mm	1000
020678	zwart	18x18 mm	11,5 mm	3 mm	5 mm	1000
020679	zwart	20x20 mm	11,5 mm	3 mm	5 mm	1000
020680	zwart	22x22 mm	11,5 mm	3 mm	5 mm	1000
020681	zwart	25x25 mm	11,5 mm	3 mm	5 mm	500
020682	zwart	30x30 mm	11,5 mm	3 mm	5 mm	500
020673	zwart	35x35 mm	14,5 mm	3 mm	5 mm	500
020674	zwart	40x40 mm	14,5 mm	3 mm	5 mm	500
020675	zwart	50x50 mm	14,5 mm	3 mm	5 mm	500

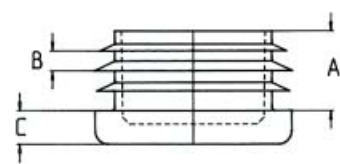

Rechthoekige stoeldop type VL

Bestelnr.	Afwerking	Oppervlak	A	B	C	Verpakking
020731	zwart	25x10 mm	11,5 mm	3 mm	4 mm	1
020745	zwart	20x15 mm	11,5 mm	3 mm	5 mm	1
020747	zwart	25x15 mm	11,5 mm	3 mm	5 mm	1
020748	zwart	30x15 mm	11,5 mm	3 mm	5 mm	1
020732	zwart	25x20 mm	11,5 mm	3 mm	5 mm	1
020749	zwart	30x20 mm	11,5 mm	3 mm	5 mm	1
020750	zwart	35x20 mm	11,5 mm	3 mm	5 mm	1
020752	zwart	40x20 mm	11,5 mm	3 mm	5 mm	1
020751	zwart	35x25 mm	11,5 mm	3 mm	5 mm	1
020734	zwart	40x25 mm	11,5 mm	3 mm	5 mm	1
020736	zwart	45x25 mm	11,5 mm	3 mm	5 mm	1
020738	zwart	50x25 mm	14,5 mm	3 mm	5 mm	1
020735	zwart	40x30 mm	11,5 mm	3 mm	5 mm	1
020739	zwart	50x30 mm	14,5 mm	3 mm	5 mm	1
020742	zwart	60x30 mm	14,5 mm	3 mm	5 mm	1

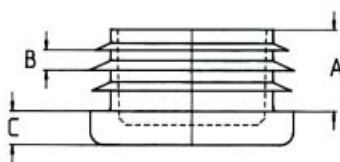

Stoeldop type GL

Bestelnr.	Afwerking	Diameter	A	B	C	Verpakking
020776	zwart	14 mm	11,5 mm	3 mm	5 mm	1000
020779	zwart	18 mm	11,5 mm	3 mm	5 mm	1000
020787	zwart	26 mm	11,5 mm	3 mm	5 mm	500
020790	zwart	30 mm	11,5 mm	3 mm	5 mm	500
020791	zwart	32 mm	11,5 mm	3 mm	5 mm	500

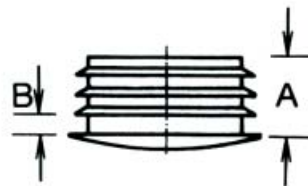
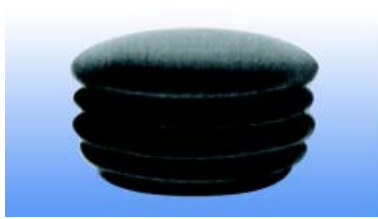

Stoeldop type SFL

Bestelnr.	Afwerking	Diameter	A	B	Verpakking
020842	zwart	25 mm	11,5 mm	3 mm	500
020843	zwart	26 mm	11,5 mm	3 mm	500

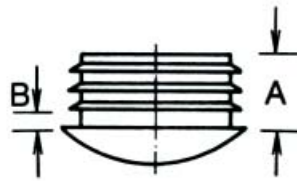

Stoeldop type SRL

Bestelnr.	Afwerking	Diameter	A	B	Verpakking
020801	zwart	10 mm	11,5 mm	2,5 mm	1000
020804	zwart	14 mm	11,5 mm	3 mm	1000
020806	zwart	16 mm	11,5 mm	3 mm	1000
020807	zwart	18 mm	11,5 mm	3 mm	1000
020808	zwart	19 mm	11,5 mm	3 mm	1000
020809	zwart	20 mm	11,5 mm	3 mm	1000
020811	zwart	22 mm	11,5 mm	3 mm	1000
020813	zwart	24 mm	11,5 mm	3 mm	500
020814	zwart	25 mm	11,5 mm	3 mm	500
020817	zwart	28 mm	11,5 mm	3 mm	500
020818	zwart	30 mm	11,5 mm	3 mm	500
020819	zwart	32 mm	11,5 mm	3 mm	500
020821	zwart	35 mm	11,5 mm	3 mm	500
020825	zwart	40 mm	11,5 mm	3 mm	500

STOELGELEIDERS



Stoelgeleider type 1804

Bestelnr.	Afwerking	Diameter	Dikte	Verpakking
020549	zwart	20 mm	10 mm	100
020550	zwart	25 mm	10 mm	100



Stoelgeleider type 6030.002

Bestelnr.	Afwerking	Diameter	Dikte	Lengte pin	Verpakking
021249	nylon wit	15 mm	5 mm	16 mm	100
020555	nylon wit	20 mm	5 mm	16 mm	100

INHANGBESLAG

INHANGBESLAG

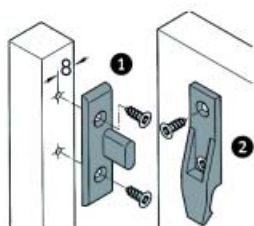
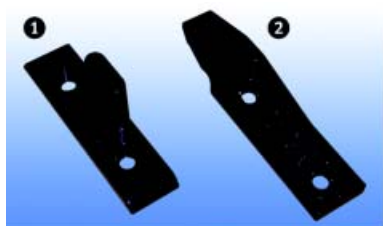

Inhangbeslag type 262.49
- voor het bevestigen van panelen
aan een kader

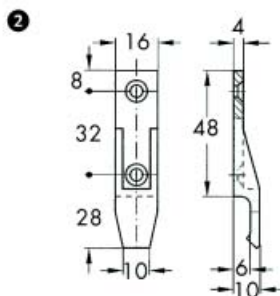
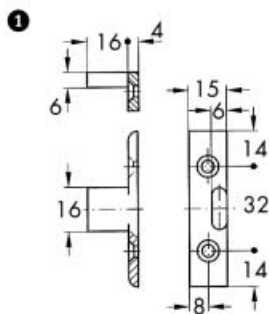

Bestelnr.	Afwerking	Omschrijving	Toepassing	Verpakking
047311	zwart	contradeel 1	te schroeven aan draagconstructie	200
047310	zwart	haakdeel 2	te schroeven aan panelen	200

VERBINDINGSPLAATJES

VERBINDINGSPLAATJES

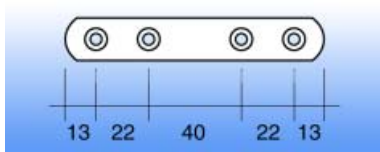

Verbindingsplaatje type 214

Bestelnr.	Afwerking	Lengte	Breedte	Dikte	Verpakking
051040	chrom	110 mm	20 mm	3 mm	200
035185	wit	110 mm	20 mm	3 mm	200
051041	zilver	110 mm	20 mm	3 mm	200

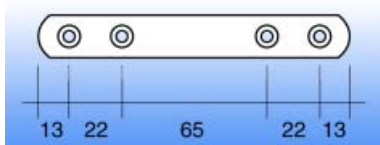

Verbindingsplaatje type 215

Bestelnr.	Afwerking	Lengte	Breedte	Dikte	Verpakking
051038	chrom	135 mm	20 mm	3 mm	200
035184	wit	135 mm	20 mm	3 mm	200
051039	zilver	135 mm	20 mm	3 mm	200



Verbindingsplaatje type 20

Bestelnr.	Afwerking	Lengte	Breedte	Dikte	Verpakking
051035	chrom	230 mm	20 mm	3 mm	150
051037	wit	230 mm	20 mm	3 mm	150
051036	zilver	230 mm	20 mm	3 mm	150



Verbindingsplaatje type 6005

Bestelnr.	Afwerking	Lengte	Verpakking
010927	verzinkt	50 mm	50
010928	verzinkt	75 mm	50
010929	verzinkt	100 mm	50
010930	verzinkt	125 mm	50
010931	verzinkt	150 mm	50
010932	verzinkt	175 mm	50

HOEKVERBINDINGEN

HOEKVERBINDINGEN

Hoekverbinding type 52.0010

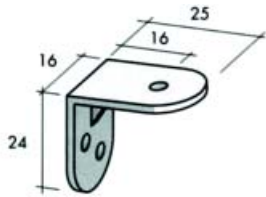

Bestelnr.	Afwerking	-	Verpakking
012939	wit		4500

Hoekverbinding type 52.0070

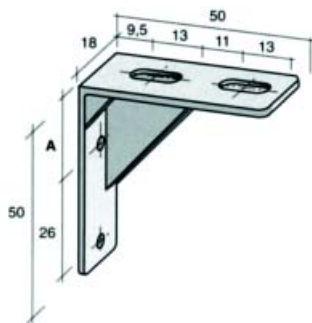

Bestelnr.	Afwerking	-	Verpakking
012941	wit		2500

Hoekverbinding type 52.0260

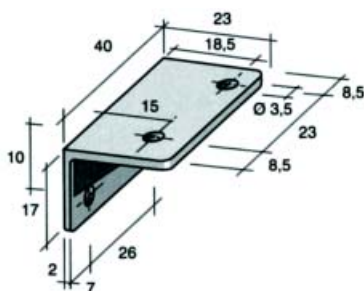

Bestelnr.	Afwerking	-	Verpakking
012943	wit		4500

Hoekverbinding type 52.0450

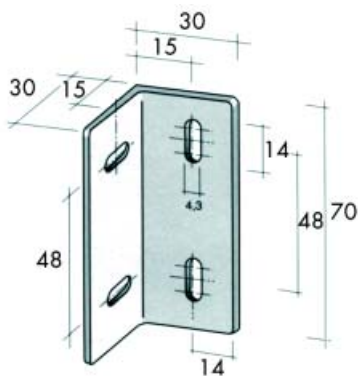

Bestelnr.	Afwerking	-	Verpakking
013083	wit		1600

Hoekverbinding type 52.0740

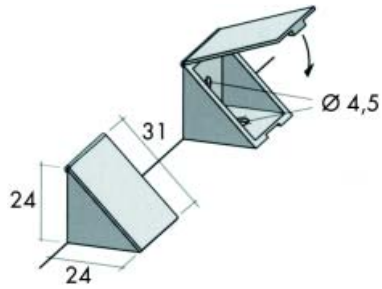

Bestelnr.	Afwerking	-	Verpakking
013148	beige		5500
013174	bruin		3300
013134	wit		3300

Hoekverbinding type 60.3840

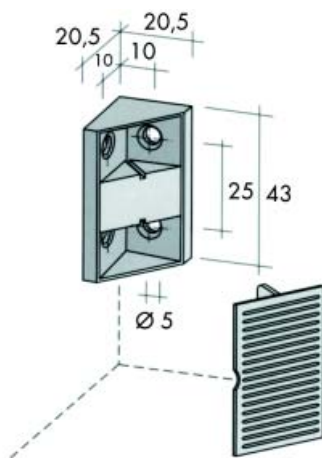

Bestelnr.	Afwerking	-	Verpakking
013144	bruin		4000
013135	wit		4000

KASTVERBINDINGEN

KASTVERBINDINGEN

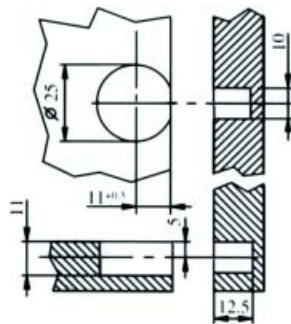

Kastverbinding type G98XA

Bestelnr.	Afwerking	-	Verpakking
030683	wit		1200

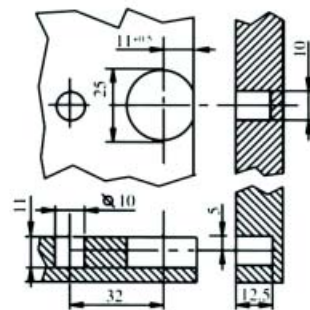

Kastverbinding type G9DXA

Bestelnr.	Afwerking	-	Verpakking
030648	wit		1200
030778	grijs		1200

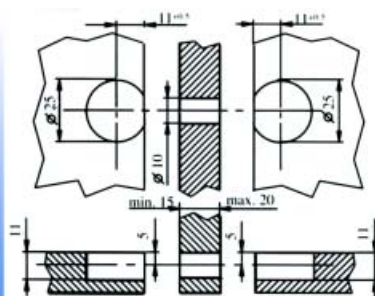

Kastverbinding type G98MA/G98FAI

- deze kastverbinding bestaat uit 2 afzonderlijk te bestellen delen

Bestelnr.	Afwerking	Omschrijving	Verpakking
030684	wit	G98MA19	1200
030685	wit	G98FAI	1200

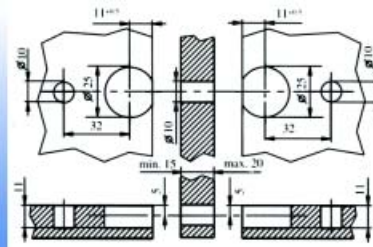

Kastverbinding type G9DMA/G9DFAI

- deze kastverbinding bestaat uit 2
afzonderlijk te bestellen delen

Bestelnr.	Afwerking	Omschrijving	Verpakking
030647	wit	G9DMA19	1200
030646	wit	G9DFA1	1200

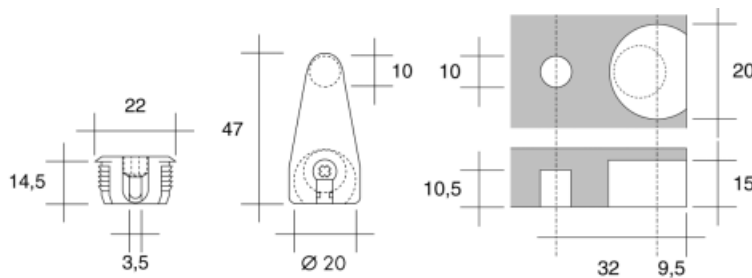

Kastverbinding type Modulfix 32V

- voor verticale montage

Bestelnr.	Afwerking	-	Verpakking
013406	vernikkeld		500

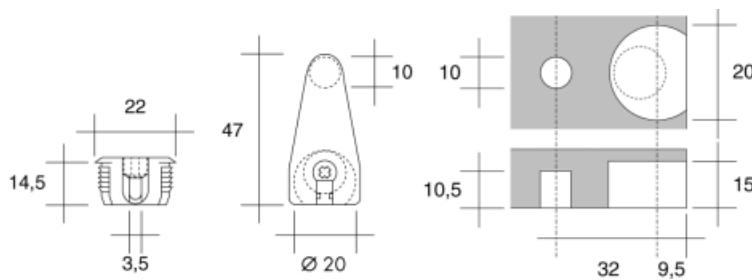

Kastverbinding type Modulfix 32LO

- kan zowel horizontaal als verticaal
gemonteerd worden

Bestelnr.	Afwerking	-	Verpakking
013484	vernikkeld		200

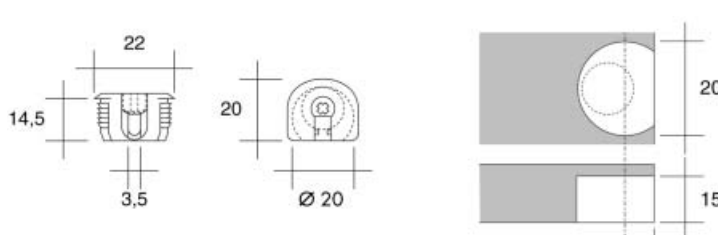

Kastverbinding type Modulfix 20

- voor verticale montage

Bestelnr.	Afwerking	-	Verpakking
013405	vernikkeld		500

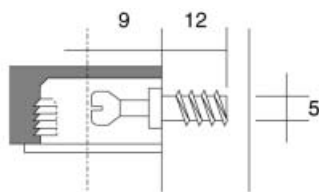
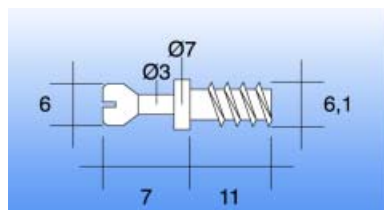

Stift voor Modulfix kastverbindingen
- euroschroef

Bestelnr.	Afwerking	-	Verpakking
013407	vernikkeld		1000

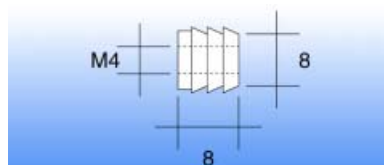

Inslagmoer voor Modulfix kastverbindingen

Bestelnr.	Afwerking	-	Verpakking
013408	nylon		1000



Tussenwandhuls type 305 I

Bestelnr.	Afwerking	-	Verpakking
013409	verzinkt		1000

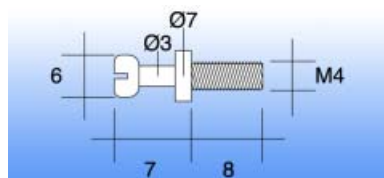

Stift met draad M4

Bestelnr.	Afwerking	-	Verpakking
013410	verzinkt		1000



Kastverbinding type Marianne
- compleet beslag met afdekkap

Bestelnr.	Afwerking	-	Verpakking
010827	bruin		1
010826	wit		1

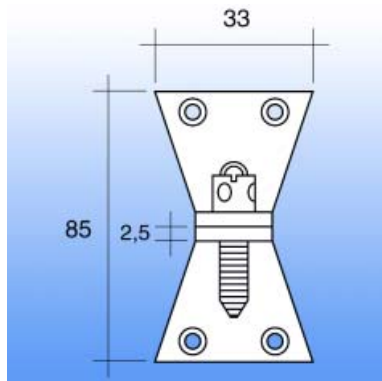

Kastverbinding type 190

Bestelnr.	Afwerking	-	Verpakking
013173			50

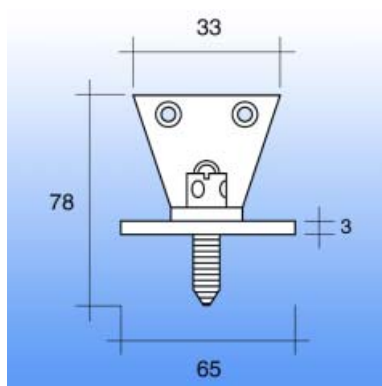

Kastverbinding type 191

Bestelnr.	Afwerking	-	Verpakking
013172			50

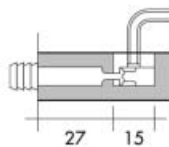
**Kastverbinding type Fixograss**

- de kastverbinder bestaat uit 3 delen die elk afzonderlijk besteld dienen te worden

Bestelnr.	Afwerking	Omschrijving	Verpakking
029604		excenter 43003 voor plaat 14-16 mm	100
029560		excenter 43007 voor plaat 17-20 mm	2000
029561		Grass verbinding M6 stift	100
029562		deugel M6x10 mm	100

KEUKENBLADVERBINDERS

KEUKENBLADVERBINDERS

Keukenbladverbinder type 665

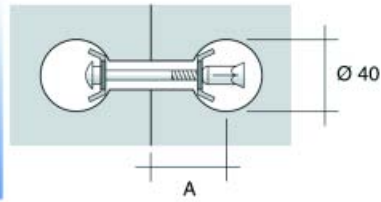
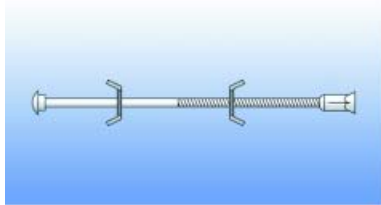

Bij keukenbladverbinder M6 x 65 mm → A = 40 mm
 Bij keukenbladverbinder M6 x 150 mm → A = 83 mm
 Aanbevolen boordiepte = $\frac{\text{dikte tablet} + 10 \text{ mm}}{2}$

Bestelnr.	Afwerking	Afmetingen	Verpakking
013034	verzinkt	M6x65 mm	I
013035	verzinkt	M6x150 mm	I

ANDERE VERBINDERS

ANDERE VERBINDERS

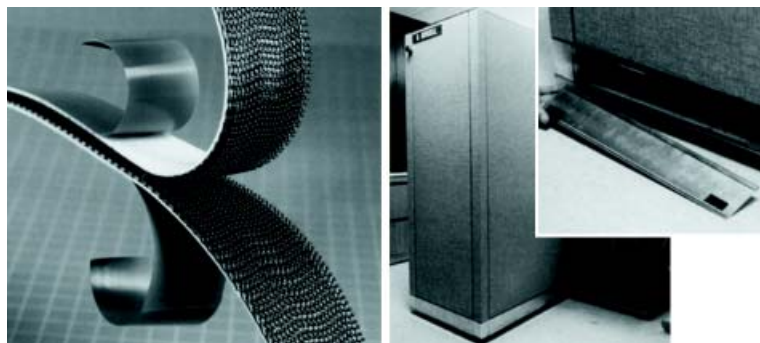
**Dual Lock klikband 3M**

- zeer grote trekkracht
- vochtbestendig
- bestand tegen UV-licht en oplosmiddelen
- hersluitbaar
- vervormt niet
- zelfklevend d.m.v. sterke acrylaatlijm
- kan geschroefd en geniet worden

Bestelnr.	Afwerking	Lengte	Verpakking
039494	transparant	2000 mm	1
039495	zwart	2000 mm	1

**Dual Lock stansdeel**

- vast te schroeven

Bestelnr.	Afwerking	Diameter	Verpakking
039496	zwart	22 mm	1

VLECHTWERK

HOUTEN VLECHTWERK



Vlechtwerk type Diagon

- diverse toepassingsmogelijkheden: deur-, meubel- en wandpanelen, paravents, radiator-bekleding, scheidingswanden...
- onzichtbaar verlijmd
- diagonaal vlechtwerk
- 1 zijde afgerond

Bestelnr.	Afwerking	Lengte	Breedte	Dikte	Verpakking
013280	beuk	2000 mm	800 mm	4 mm	1
013281	eik	2000 mm	800 mm	4 mm	1



Vlechtwerk type Meran

- diverse toepassingsmogelijkheden: deur-, meubel- en wandpanelen, paravents, radiator-bekleding, scheidingswanden...
- onzichtbaar verlijmd
- rugzijde in dezelfde houtsoort afgewerkt

Bestelnr.	Afwerking	Lengte	Breedte	Dikte	Verpakking
013299	beuk	2000 mm	800 mm	8 mm	1



Vlechtwerk type Classico

- diverse toepassingsmogelijkheden: deur-, meubel- en wandpanelen, paravents, radiator-bekleding, scheidingswanden...
- onzichtbaar verlijmd

Bestelnr.	Afwerking	Lengte	Breedte	Dikte	Verpakking
013300	rotan	2000 mm	800 mm	10 mm	1

**Vlechtwerk type Modena**

- diverse toepassingsmogelijkheden: deur-, meubel- en wandpanelen, paravents, radiator-bekleding, scheidingswanden...
- onzichtbaar verlijmd

Bestelnr.	Afwerking	Lengte	Breedte	Dikte	Verpakking
013301	rotan	2000 mm	600 mm	8,6 mm	I

RIETEN VLECHTWERK**Rieten vlechtwerk**

- per rol van 15 meter

Bestelnr.	Afwerking	Lengte	Breedte	Verpakking
020866	riet	15 m	450 mm	I
020867	riet	15 m	500 mm	I
020868	riet	15 m	600 mm	I
020869	riet	15 m	760 mm	I
020870	riet	15 m	910 mm	I

LUCHTROOSTERS

HOUTEN LUCHTROOSTERS

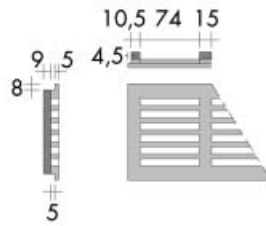
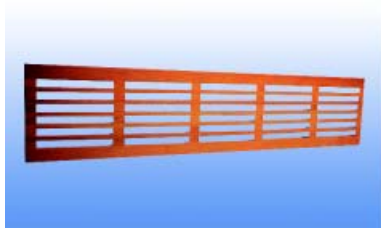

Houten luchtrooster

Bestelnr.	Afwerking	Lengte x breedte	Inbouwmaat	Verpakking
039472	beuk	80 x 550 mm	64 x 541 mm	1
039470	eik	80 x 550 mm	64 x 541 mm	1
039473	beuk	120 x 550 mm	104 x 541 mm	1
039471	eik	120 x 550 mm	104 x 541 mm	1

KROONLIJSTEN

KROONLIJSTEN

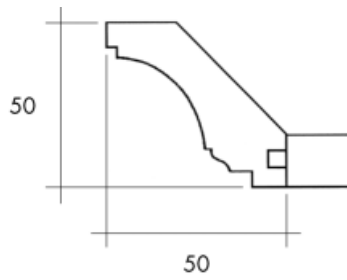

Kroonlijst type GD
- met tegenprofiel

Bestelnr.	Afwerking	Lengte	Hoogte	Diepte	Verpakking
053938	wit amerikaanse eik	+/- 3 m	50 mm	50 mm	I

BALUSTERS

BALUSTERS

Baluster op lat



Bestelnr.	Afwerking	Lengte	Hoogte	Verpakking
038416	Franse eik	2450 mm	65 mm	I

Keukenbaluster



Bestelnr.	Afwerking	Hoogte	Verpakking
054559	eik	80 mm	I

SETS DRAAIBODEMS SYSTEEM I

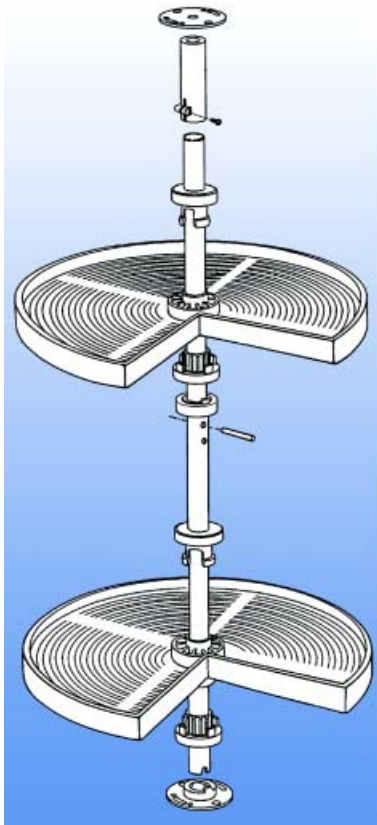

- sets voor deuren gemonteerd aan de kast
- 3 verschillende draaibodems mogelijk
- lengte van de as: 640 mm

SETS TYPE CT 122 MET 3/4 DRAAIBODEMS

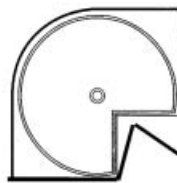
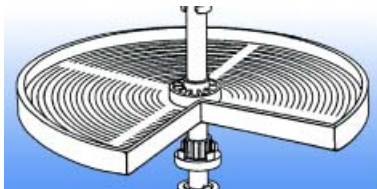

- voor deuren gemonteerd aan de kast
- compleet beslag met 2 of 3 draaibodems
- 3 verschillende maten

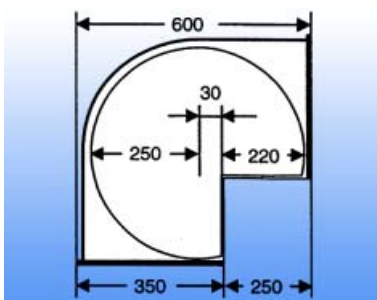

Set CT 122 voor een hoekkast van 600 x 600 mm

Bestelnr.	Afwerking	Aantal draaibodems	Inbouwhoogte	Verpakking
039281	wit	2	690-750 mm	1
039322	wit	3	690-750 mm	1

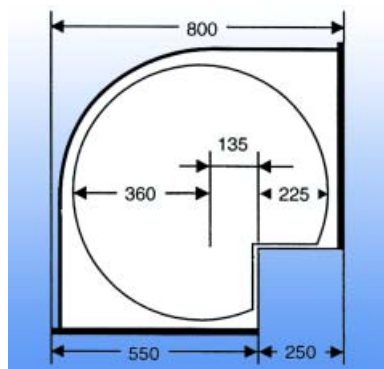

Set CT 122 voor een hoekkast van 800 x 800 mm

Bestelnr.	Afwerking	Aantal draaibodems	Inbouwhoogte	Verpakking
039282	wit	2	690-750 mm	I

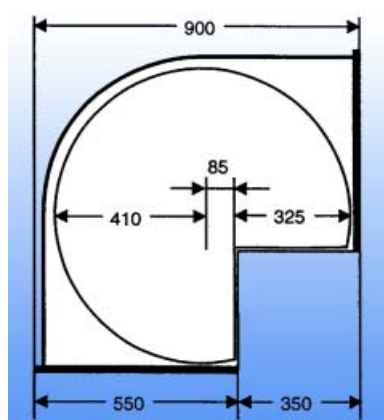

Set CT 122 voor een hoekkast van 900 x 900 mm

Bestelnr.	Afwerking	Aantal draaibodems	Inbouwhoogte	Verpakking
039283	wit	2	690-750 mm	I
039317	wit	3	700-770 mm	I

SETS TYPE CT 122 MET DRAAIBODEMS MET 1 SCHUINE ZIJDE

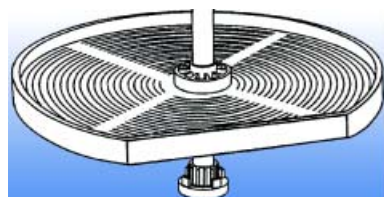

- voor 1 deur gemonteerd aan de kast
- compleet beslag met 2 of 3 draaibodems
- 3 verschillende maten

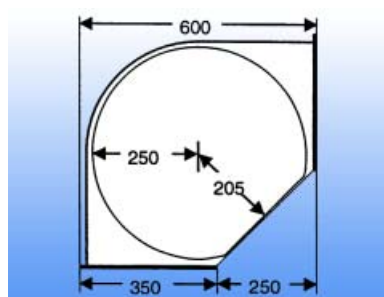

Set CT 122 voor een hoekkast van 600 x 600 mm

Bestelnr.	Afwerking	Aantal draaibodems	Inbouwhoogte	Verpakking
039287	wit	2	690-750 mm	I
039323	wit	3	690-750 mm	I

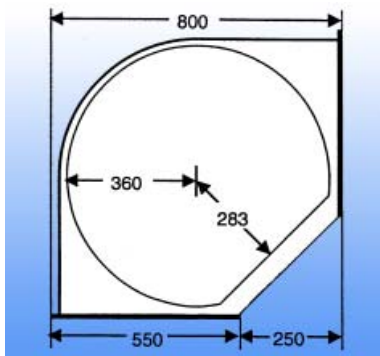

Set CT 122 voor een hoekkast van 800 x 800 mm

Bestelnr.	Afwerking	Aantal draaibodems	Inbouwhoogte	Verpakking
039288	wit	2	690-750 mm	I

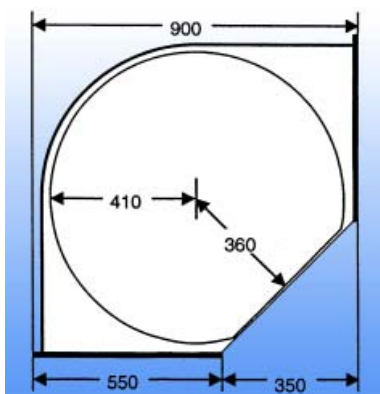

Set CT 122 voor een hoekkast van 900 x 900 mm

Bestelnr.	Afwerking	Aantal draaibodems	Inbouwhoogte	Verpakking
039289	wit	2	690-750 mm	I

SETS TYPE CT 120 MET 4/4 DRAAIBODEMS ZONDER REM

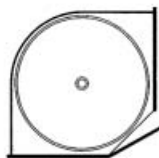

- voor 1 deur gemonteerd aan de kast
- compleet beslag met 2 of 3 draaibodems
- 3 verschillende maten

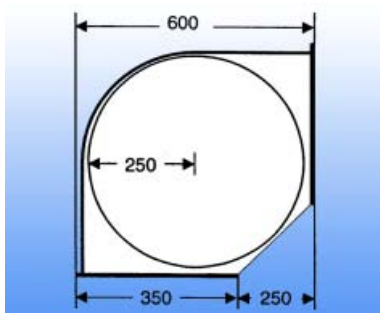

Set CT 120 voor een hoekkast van 600 x 600 mm

Bestelnr.	Afwerking	Aantal draaibodems	Inbouwhoogte	Verpakking
039290	wit	2	690-750 mm	I
039485	wit	3	690-750 mm	I

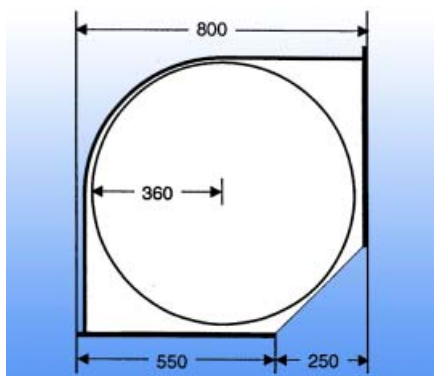

Set CT 120 voor een hoekkast van 800 x 800 mm

Bestelnr.	Afwerking	Aantal draaibodems	Inbouwhoogte	Verpakking
039291	wit	2	690-750 mm	I

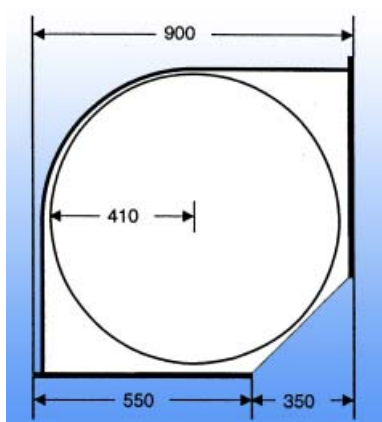

Set CT 120 voor een hoekkast van 900 x 900 mm

Bestelnr.	Afwerking	Aantal draaibodems	Inbouwhoogte	Verpakking
039292	wit	2	690-750 mm	I

SETS DRAAIBODEMS SYSTEEM 2

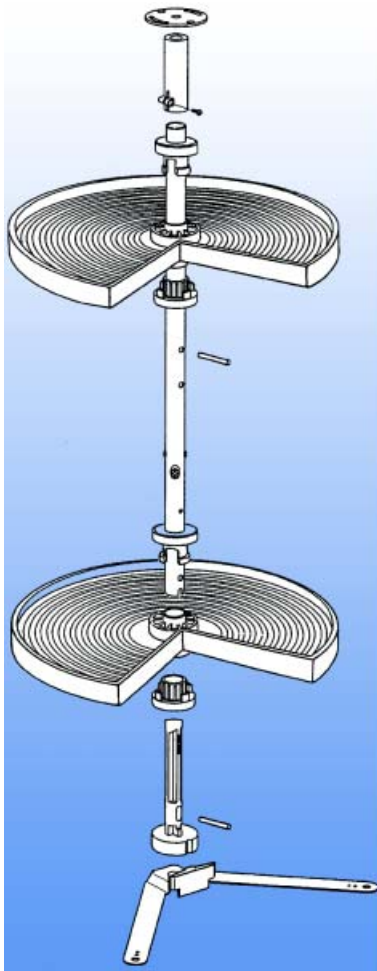

- bij dit systeem moet de bodem lager zijn dan bij de andere kasten
- set voor meedraaiende deuren gemonteerd in een hoek van 90°
- compleet beslag met 2 draaibodems
- lengte van de as: 680 mm

SETS TYPE CT 211 MET 3/4 DRAAIBODEMS

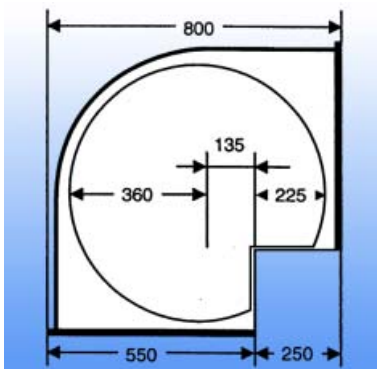

Set CT 211 voor een hoekkast van 800 x 800 mm

Bestelnr.	Afwerking	Aantal draaibodems	Inbouwhoogte	Verpakking
039293	wit	2	690-750 mm	I

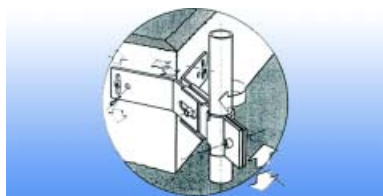

Frontbevestiging

- voorkomt dat de deur zakt wanneer er een zwaar voorwerp op de draaibodem wordt geplaatst

Bestelnr.	Afwerking	Lengte	Verpakking
039318	-	190 mm	I

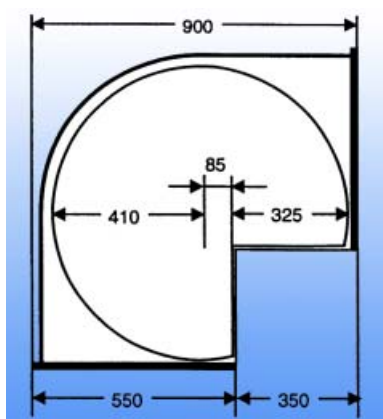

Set CT 211 voor een hoekkast van 900 x 900 mm

Bestelnr.	Afwerking	Aantal draaibodems	Inbouwhoogte	Verpakking
039294	wit	2	690-750 mm	I

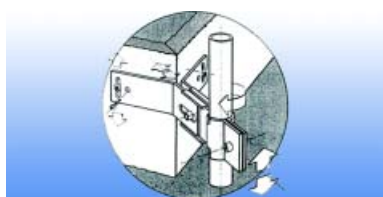

Frontbevestiging

- voorkomt dat de deur zakt wanneer er een zwaar voorwerp op de draaibodem wordt geplaatst

Bestelnr.	Afwerking	Lengte	Verpakking
039320	-	125 mm	I

SETS DRAAIBODEMS SYSTEEM 3

HOEKDRAAIBESLAG REVO 90

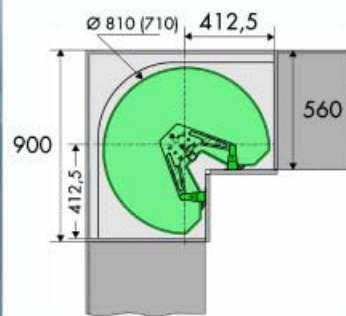
**Complete set beslag Revo 90**

- compleet beslag zonder draaibodems of -korven
- deze set is enkel voor hoekkasten met een rechte houten rug, niet voor ronde kasten
- voor kasten met houtdikte 16-19 mm

Bestelnr.	Afwerking	Voor kastbreedte	Voor binnelhoogte	Referentie	Verpakking
051278	zilver	80-90 cm	66-86 cm	6940	set

DRAAIBODEMS VOOR SYSTEEM 3

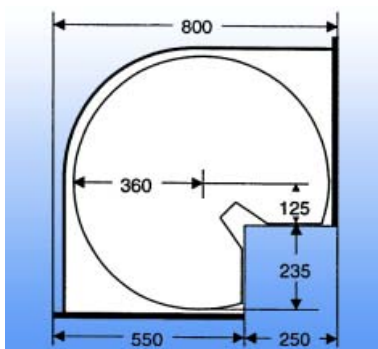
**Set CT 710 voor een hoekkast van 800 x 800 mm**

Bestelnr.	Afwerking	Aantal draaibodems	Verpakking
040234	wit	2	20

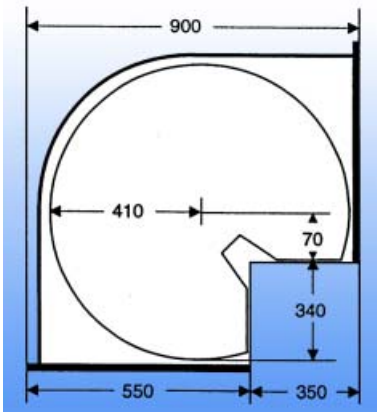

**Set CT 810 voor een hoekkast van
900 x 900 mm**

Bestelnr.	Afwerking	Aantal draaibodems	Verpakking
040235	wit	2	20

SETS DRAAIBODEMS SYSTEEM 4

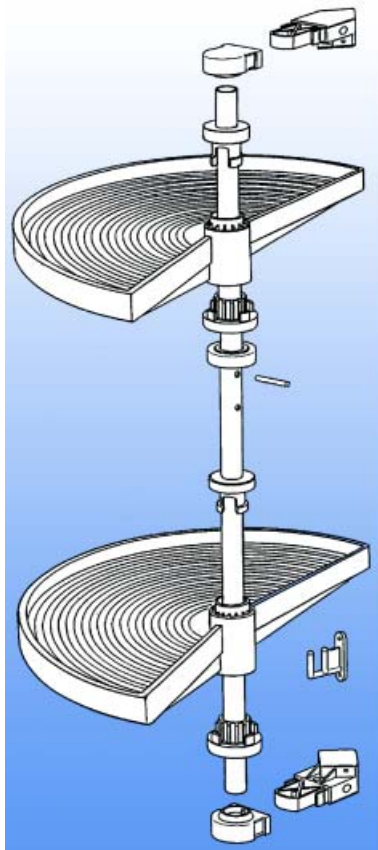

- sets voor deuren gemonteerd aan
- compleet beslag met 2 of 3 draait
- lengte van de as: 525 mm

Type ST 522 voor montage op stijl



Type ST 523 voor montage op vlak

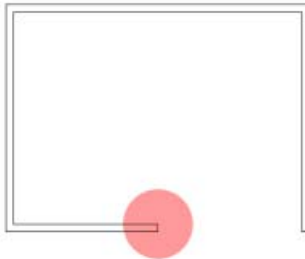

SETS TYPE ST 522/523

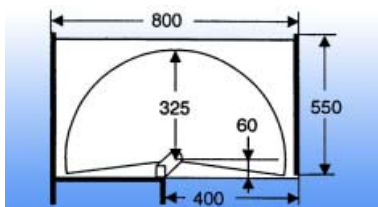

Set ST 522/523 voor een hoekkast van 800 mm
- clipsmontage

Bestelnr.	Afwerking	Aantal draaibodems	Type	Verpakking
039306	wit	2	ST 522	I
039309	wit	2	ST 523	I

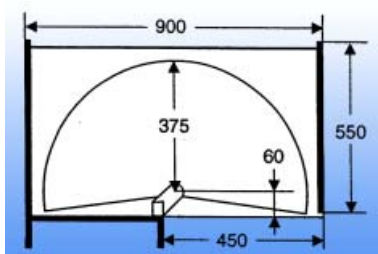

Set ST 522/523 voor een hoekkast van 900 mm
- clipsmontage

Bestelnr.	Afwerking	Aantal draaibodems	Type	Verpakking
039307	wit	2	ST 522	I
039360	wit	3	ST 522	I
039310	wit	2	ST 523	I

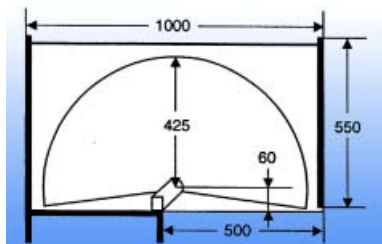

Set ST 522/523 voor een hoekkast van 1000 mm
 - clipsmontage

Bestelnr.	Afwerking	Aantal draaibodems	Type	Verpakking
039308	wit	2	ST 522	I
039311	wit	2	ST 523	I

SMOVE DEURDEMPERS

SMOVE DEURDEMPERS VOOR MONTAGE OP HET MEUBEL

**Smove deurdemper type D005SNG**

- te monteren tegenover de scharnierzijde
- in te boren of te gebruiken met adapter

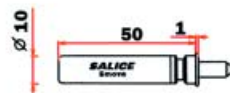

Bestelnr.	Afwerking	-	Verpakking
032084	oranje	-	2000

**Smove deurdemper type D006SNG**

- centraal te monteren bovenaan de kast
- in te boren of te gebruiken met adapter

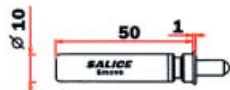

Bestelnr.	Afwerking	-	Verpakking
032223	wit/grijs	-	2000



Smove deurdemper type D008SNG

- bovenaan of onderaan de kast te monteren op 27 mm van de deur
- in te boren of te gebruiken met adapter

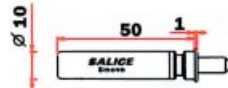

Bestelnr.	Afwerking		Verpakking
032207	grijs	-	2000

ADAPTERS VOOR VOORGAANDE SMOVE DEURDEMPERS

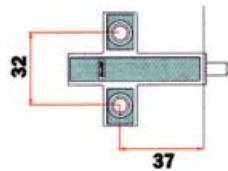
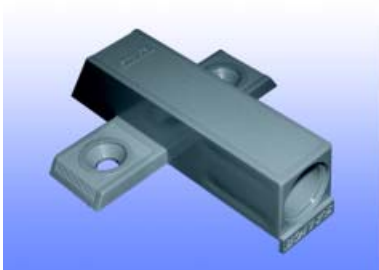
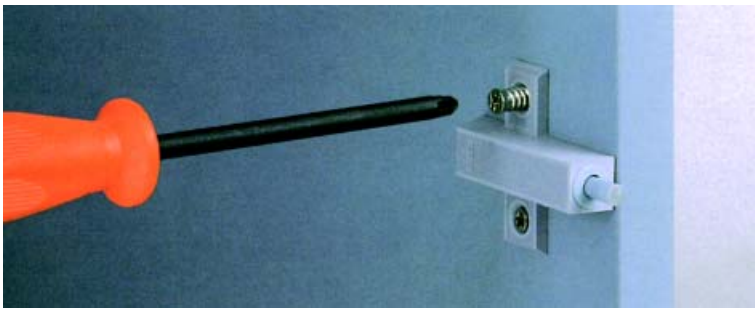

Smove adapter type D064SNGN

- universele adapter voor Smove deurdemper
- voor houtschroeven
- met lip

Bestelnr.	Afwerking		Verpakking
032253	grijs	-	500

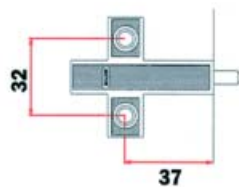

Smove adapter type D064SNGR

- universele adapter voor Smove deurdemper
- voor houtschroeven
- zonder lip

Bestelnr.	Afwerking		Verpakking
032254	grijs	-	500

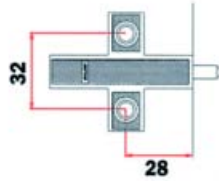
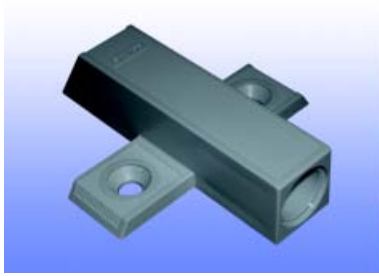
**Smove adapter type D060SNGR**

- universele adapter voor Smove deurdemper
- voor houtschroeven
- zonder lip

Bestelnr.	Afwerking	-	Verpakking
029141	grijs	-	500

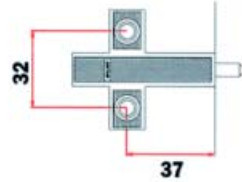
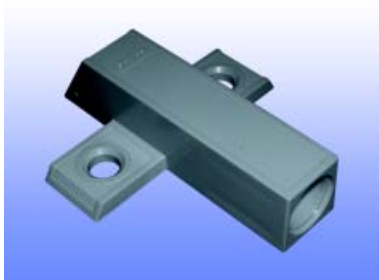
**Smove adapter type D065SNGR**

- universele adapter voor Smove deurdemper
- voor Euroschroeven
- zonder lip

Bestelnr.	Afwerking	-	Verpakking
031781	grijs	-	500

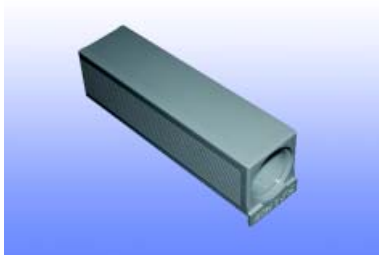
ZELFKLEVENDE ADAPTERS VOOR VOORGAANDE SMOVE DEURDEMPERS**Smove adapter type D051 SNG**

- universele adapter voor Smove deurdemper
- zelfklevend

Bestelnr.	Afwerking	Afmetingen	Verpakking
032205	grijs	14x14x53 mm	500

SMOVE DEURDEMPERS VOOR MONTAGE OP DE DEUR

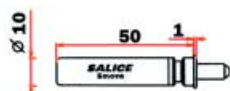
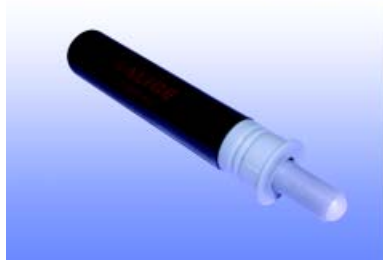

Smove deurdemper type D009SNX

- te monteren op de deur
- te gebruiken met adapter

Bestelnr.	Afwerking	-	Verpakking
032481	zwart/grijs	-	2000

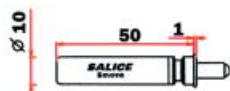
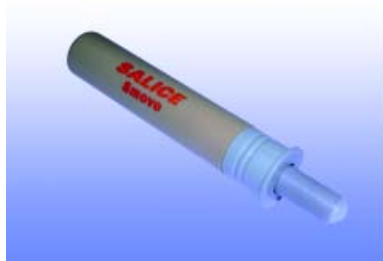

Smove deurdemper type D010SNX

- te monteren op de deur
- voor deuren met 4 scharnieren
- te gebruiken met adapter

Bestelnr.	Afwerking	-	Verpakking
032482	beige/grijs	-	2000

ADAPTER VOOR SMOVE DEURDEMPERS VOOR MONTAGE OP DE DEUR

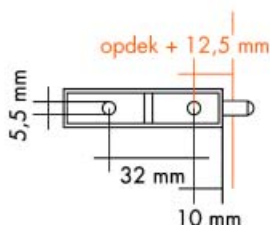
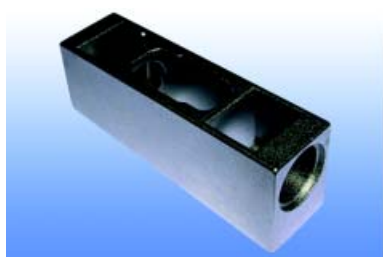

Smove adapter type D078XX9

- adapter voor Smove deurdemper
- voor montage op deur
- te gebruiken met Salice afdekkap

Bestelnr.	Afwerking	-	Verpakking
032483	nikkel	-	1

SALICE AFDEKKAPPEN



Stalen afdekkappen type S2BX83 voor scharnieren type 200 en F
- mogelijkheid tot personalisatie met uw logo

Bestelnr.	Afwerking	-	-	Type	Verpakking
030067	metaal	-	-	S2BX83H9	2000

ANDERE DEURDEMPERS

ANDERE DEURDEMPERS

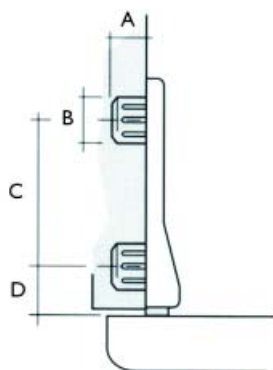

Deurdemper type 59.0010, 59.0130 en 59.0300

Bestelnr.	Afwerking	A	B	C	D	Type	Verpakking
012948	bruin	10 mm	6,5 mm	32 mm	20 mm	59.0010	2800
012950	eik	10 mm	6,5 mm	32 mm	20 mm	59.0010	2800
012947	wit	10 mm	6,5 mm	32 mm	20 mm	59.0010	2800
012955	wit	10 mm	6,5 mm	16 mm	16,5 mm	59.0130	4500
012960	wit	10 mm	7,5 mm	32 mm	16,5 mm	59.0300	2800

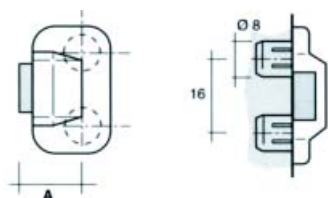

Deurdemper type 59.0100 en 59.0600

Bestelnr.	Afwerking	A	Verpakking
013085	bruin	14 mm	1500
012965	wit	14 mm	1500

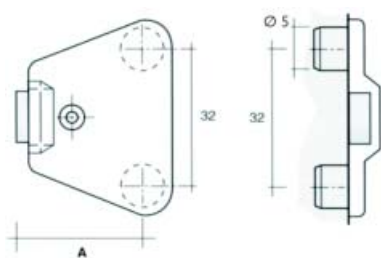

Deurdemper type 59.0110

Bestelnr.	Afwerking	-	Verpakking
012953	wit		2300

Deurdemper type 59.0200

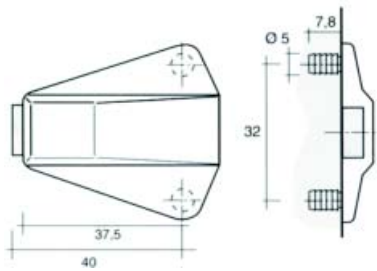

Bestelnr.	Afwerking	-	Verpakking
012959	beige		1500
013207	bruin		1500
013205	wit		1500
013206	zwart		1500

Deurdemper type 59.0420

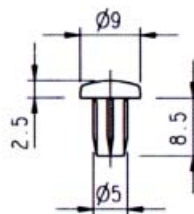

Bestelnr.	Afwerking	-	Verpakking
013032	transparant		5000

Deurdemper type 59.0450

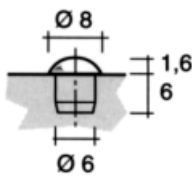

Bestelnr.	Afwerking	A	B	C	Verpakking
021448	transparant	l mm	7 mm	5 mm	5000

Deurdemper type 52

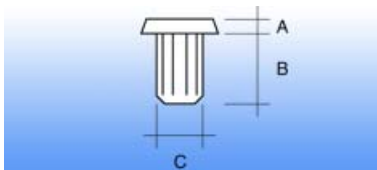

Bestelnr.	Afwerking	A	B	C	Verpakking
002009	bruin	l mm	6 mm	5 mm	l
003221	wit	l mm	6 mm	5 mm	l
003222	zwart	l mm	6 mm	5 mm	l

Deurdemper type 3215E

- zelfklevende deurdempers
- 50 stuks per kaart

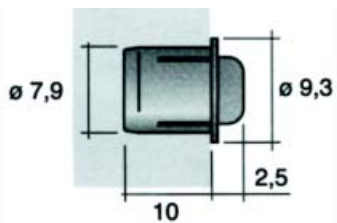
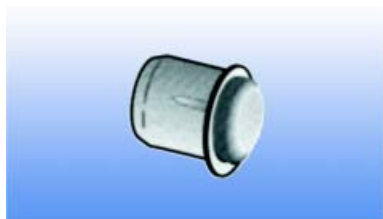

Bestelnr.	Afwerking	-	Verpakking
002015	transparant		50

**Deurdemper type Dyno Stop**

- tweedelige deurdemper zorgt voor geruisloze sluiting

Bestelnr.	Afwerking	-	Verpakking
013400	zilver/wit		6000

DEURBESCHERMER

DEURBESCHERMER

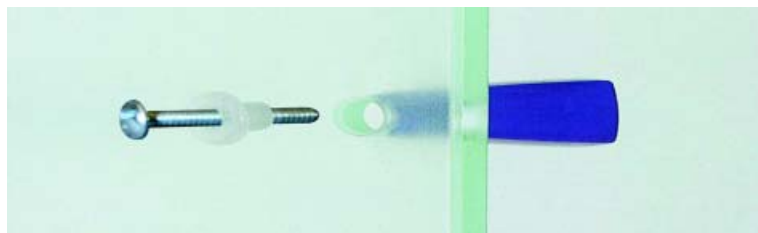
**Huls type D6**

- beschermt een glasdeur bij montage van een trekker of greep
- voor een boring van \varnothing 6 mm door het glas

Bestelnr.	Afwerking	Voor glasdikte	Verpakking
013156	Transparant	4 mm	1

CONSOLEN

CONSOLEN

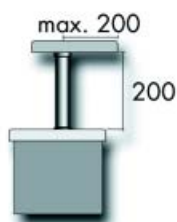

Barconsole type 9103/9105

- rechte console

Bestelnr.	Afwerking	Diameter	Montage	Type	Verpakking
050827	chrom	50 mm	te schroeven	9103	I
050852	mat chrom	50 mm	te schroeven	9103	I
051236	chrom	50 mm	te kleven	9105	I
051235	mat chrom	50 mm	te kleven	9105	I

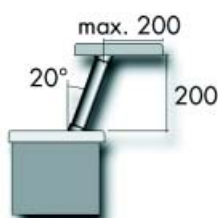

Barconsole type 9104/9106

- schuine console

Bestelnr.	Afwerking	Diameter	Montage	Type	Verpakking
050867	chrom	50 mm	te schroeven	9104	I
050868	mat chrom	50 mm	te schroeven	9104	I
051237	chrom	50 mm	te kleven	9106	I
051238	mat chrom	50 mm	te kleven	9106	I

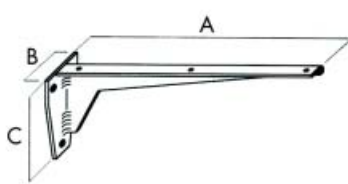

Vaste console type FL

- draagkracht per paar: 150 kg

Bestelnr.	Afwerking	A	B	C	Verpakking
011188	verzinkt	150 mm	36 mm	70 mm	I
011189	verzinkt	175 mm	36 mm	70 mm	I
011190	verzinkt	200 mm	46 mm	80 mm	I
011191	verzinkt	240 mm	46 mm	80 mm	I
011192	grijs	280 mm	53 mm	100 mm	I
011193	grijs	330 mm	53 mm	100 mm	I
011194	grijs	380 mm	65 mm	130 mm	I
011195	grijs	480 mm	65 mm	130 mm	I
011196	grijs	580 mm	82 mm	170 mm	I
011197	grijs	680 mm	82 mm	170 mm	I

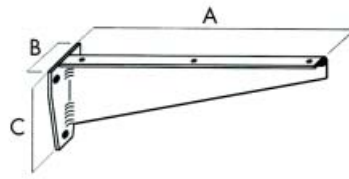

Vaste console type P

- draagkracht per paar: 100 kg

Bestelnr.	Afwerking	A	B	C	Verpakking
013092	grijs	480 mm	65 mm	130 mm	I

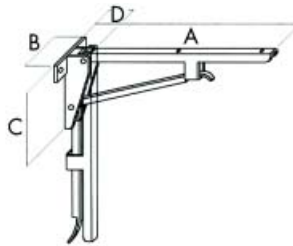

Klapconsole type KL

- draagkracht per paar: 150 kg

Bestelnr.	Afwerking	A	B	C	D	Verpakking
011174	verzinkt	200 mm	60 mm	80 mm	35 mm	I
011175	verzinkt	240 mm	60 mm	105 mm	35 mm	I
011176	verzinkt	280 mm	60 mm	105 mm	35 mm	I
011177	grijs	330 mm	82 mm	130 mm	50 mm	I
011178	grijs	380 mm	82 mm	130 mm	50 mm	I
011179	grijs	480 mm	82 mm	145 mm	50 mm	I
011180	grijs	580 mm	82 mm	172 mm	50 mm	I
011181	grijs	680 mm	82 mm	172 mm	50 mm	I

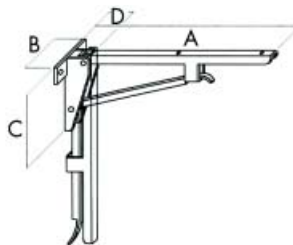

Klapconsole type KS

- draagkracht per paar: 500 kg

Bestelnr.	Afwerking	A	B	C	D	Verpakking
011187	grijs	780 mm	115 mm	220 mm	60 mm	I

KESSEBÖHMER SKYLINE LUIFELOPHANGER



Buis voor luifelophanger

Bestelnr.	Afwerking	Lengte	Diameter	Verpakking
050896	chroom	500 mm	25 mm	1
050897	chroom mat	500 mm	25 mm	1
050898	chroom	750 mm	25 mm	1
050899	chroom mat	750 mm	25 mm	1
050900	chroom	1000 mm	25 mm	1
050901	chroom mat	1000 mm	25 mm	1



Bevestigingsset type 9023

- bevestigingsset voor luifelophanger
- per set

Bestelnr.	Afwerking	Type	Verpakking
050902	chroom	9023	set
050903	chroom mat	9023	set



Bevestigingsset type 9024

- deze bevestigingsset dient u enkel te bestellen wanneer u meer dan 1 blad gebruikt
- per set

Bestelnr.	Afwerking	Type	Verpakking
050904	chroom	9024	set
050905	chroom mat	9024	set

LUIFELOPHANGER 600



Luifelophanger type 600
- in de lengte verstelbaar

Bestelnr.	Afwerking	Lengte	Diameter	Verpakking
039205	chrom	400-900 mm	21 mm	10
039206	messing	400-900 mm	21 mm	10
039207	wit	400-900 mm	21 mm	10
039208	zwart	400-900 mm	21 mm	10

PROFIELEN VOOR ALUMINIUM DEURFRAME

ALU DEURPROFIELEN

De aluminium deurprofielen worden samengesteld d.m.v. 2 aparte sets:

- 1 set met boven- en onderprofiel,
- 1 set met 2 zijprofielen, waarvan 1 voorzien van scharniergaten.

De set met zijprofielen bevat tevens:

- 4 schroeven voor de montage van de scharnieren,
- 8 schroeven voor de montage van de deur.

De profielen zijn voorzien van voorgemonteerde glasdichtingen.

Geschikt voor glas van 4 mm dik.

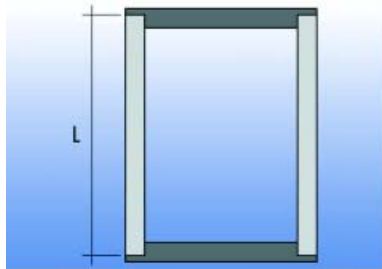

Scharnier voor alu deurframe

- standaard meegeleverd
- opliggende scharnier
- openingshoek: 105°
- met veer



Montageplaat voor alu deurframe

- Domi clip montageplaat
- frontale en verticale regeling d.m.v. excenter
- traploos in hoogte verstelbaar

Zijprofielen voor aluminium deurframe

- set bevat 2 zijprofielen waarvan 1 met scharniergaten, 4 schroeven voor de montage van de scharnieren en 8 schroeven voor de montage van de deur.
- inclusief scharnieren
- 4 verschillende lengtes die tot 90 mm kunnen worden ingekort.
- voorzien van voorgemonteerde glasdichting.

Bestelnr.	Afwerking	Lengte	Kan ingekort worden tot	Verpakking
047200	mat aluminium	800 mm	570 mm	set
047201	mat aluminium	1150 mm	800 mm	set
047202	mat aluminium	1500 mm	1120 mm	set
047203	mat aluminium	2200 mm	1820 mm	set

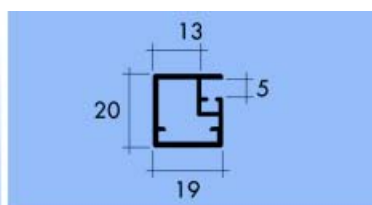
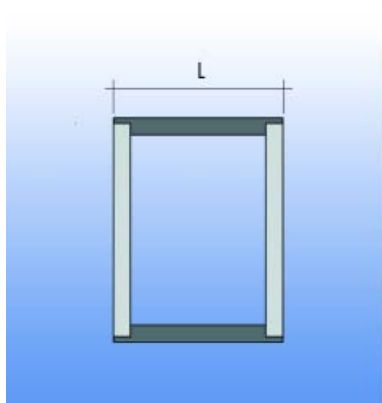

Montage:

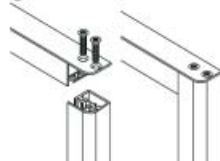

Boven- en onderprofielen voor aluminium deurframe

- set bevat boven- en onderprofiel
- 5 verschillende lengtes
- voorzien van voorgemonteerde glasdichting

Bestelnr.	Afwerking	Lengte	Verpakking
047204	mat aluminium	295 mm	set
047205	mat aluminium	395 mm	set
047206	mat aluminium	445 mm	set
047207	mat aluminium	495 mm	set
047208	mat aluminium	595 mm	set

ALUMINIUM DEURPROFIEL SALICE

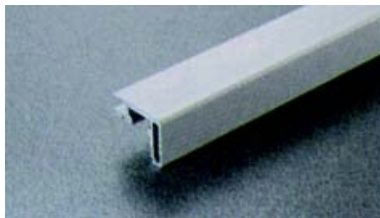

Aluminium deurprofiel

- het aluminium deurprofiel is voorzien van een U-vormig kunststof glasprofiel
- het aluminium deurprofiel is 3000 mm lang en dient op de gewenste maat in verstek gezaagd te worden

Bestelnr.	Afwerking	Lengte	Voor glasdikte	Verpakking
031938	aluminium	3000 mm	4 mm	12



Hoekverbinder voor aluminium deurprofiel

- de hoekverbinder klemt zich in het aluminium deurprofiel d.m.v. 4 schroeven

Bestelnr.	Afwerking		Verpakking
031943	-	-	1

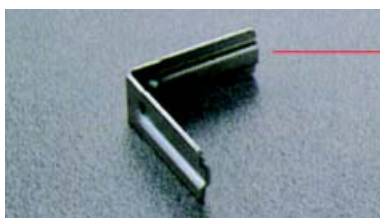

Hoekversteving voor aluminium deurprofiel

- als extra versteving bovenop de hoekverbinder

Bestelnr.	Afwerking		Verpakking
031944	-	-	1

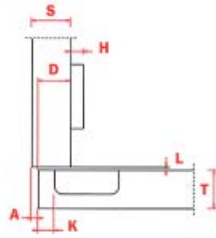

Scharnier type C206A99 voor het aluminium deurprofiel

- rechte scharnier
- deze scharnier kan op alle Salice plaatjes bevestigd worden

Bestelnr.	Afwerking	-	Verpakking
031940	nikkel	-	150

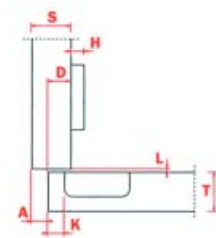

Scharnier type C206D99 voor het aluminium deurprofiel

- gekraakte scharnier 5 mm
- deze scharnier kan op alle Salice plaatjes bevestigd worden

Bestelnr.	Afwerking	-	Verpakking
031941	nikkel	-	150

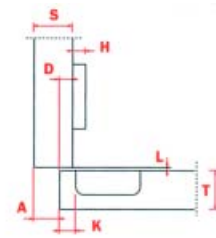

Scharnier type C206G99 voor het aluminium deurprofiel

- gekraakte scharnier 9 mm
- deze scharnier kan op alle Salice plaatjes bevestigd worden

Bestelnr.	Afwerking	-	Verpakking
031942	nikkel	-	150

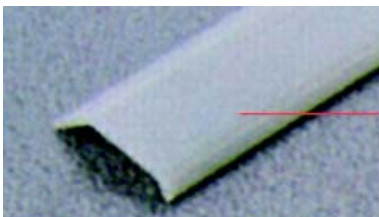

Afdekprofiel voor aluminium deurprofiel

- kunststof afdekprofiel voor de afwerking van de binnenzijde van het aluminium deurprofiel
- het kunststof afdekprofiel is 3000 mm lang en dient op maat gezaagd te worden

Bestelnr.	Afwerking	-	Verpakking
031939	aluminium	-	120



Adapter voor montage met gasveren

Bestelnr.	Afwerking	-	Verpakking
032154	-	-	150

Montage:

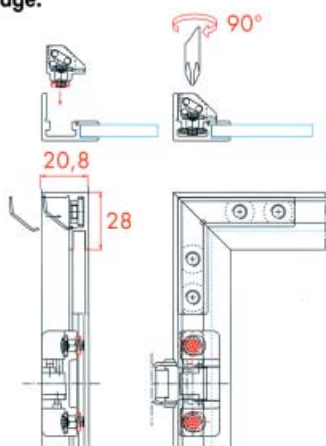

Het aluminium deurprofiel wordt op maat in verstek gezaagd.

Plaats de hoekverbinder in het profiel en zet vast d.m.v. de voorgemonteerde schroeven.

Het glas moet geplaatst worden voordat alle hoekverinders worden vastgezet.

Snijdt het afdekprofiel op maat.

Plaats het afdekprofiel in het aluminium deurprofiel.

Snijdt het afdekprofiel door op de plaats waar de scharnieren worden geplaatst.

ALU GLASSCHUIFDEURPROFIELEN

De glasschuifdeur wordt samengesteld met de volgende onderdelen:

- set horizontale profielen en toebehoren voor 2 deuren: deze set bevat 4 horizontale deurprofielen (2 x boven en onder) met vaste lengte (459, 509 en 609 mm), 4 glijwielen, 4 geleiders, 4 stoppers en schroeven.
- verticaal deurprofiel op lengte (3900 mm) dat op maat dient te worden gezaagd.
- bodemprofiel op lengte (3900 mm) dat op maat dient te worden gezaagd.
- bovenprofiel op lengte (3900 mm) dat op maat dient te worden gezaagd.

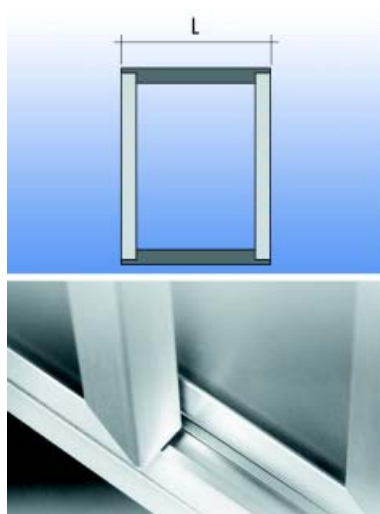

Toebehoren:

4 glijwielen (2 per deur) passend in de vorgeboorde montagegaten van de bodemprofielen



4 geleiders (2 per deur) passend in de vorgeboorde montagegaten van de bovenprofielen



4 stoppers, passend in de bovenprofielen. De bovenprofielen dienen wel apart besteld te worden.



Alle schroeven nodig voor montage, passend in de vorgeboorde montagegaten



Set horizontale profielen en toebehoren voor 2 deuren

- set bevat 4 horizontale profielen met vaste lengte (L) voorzien van schroefgaten en montagegaten voor geleiders en glijwielen, en toebehoren
- voorzien van voorgemonteerde glasdichtingen.
- geschikt voor glas van 4 mm dik.

Bestelnr.	Afwerking	Lengte	Voor corpus	Verpakking
047304	mat aluminium	459 mm	900 mm	set
047305	mat aluminium	509 mm	1000 mm	set
047306	mat aluminium	609 mm	1200 mm	set

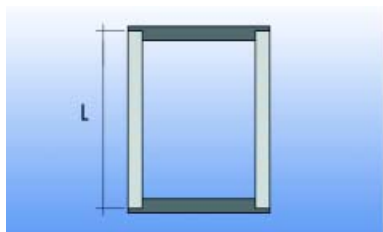
**Verticaal bovenprofiel**

- het profiel is voorzien van een voorgemonteerde glasdichting.
- geschikt voor glas van 4 mm dik.
- dient op de gewenste lengte (L) gezaagd te worden
- maximum deurhoogte 1500 mm

Bestelnr.	Afwerking	Lengte	Verpakking
047307	mat aluminium	3900 mm	I

**Bodemprofiel**

- dient op de gewenste lengte gezaagd te worden

Bestelnr.	Afwerking	Lengte	Verpakking
047308	mat aluminium	3900 mm	I

**Bovenprofiel**

- dient op de gewenste lengte gezaagd te worden

Bestelnr.	Afwerking	Lengte	Verpakking
047309	mat aluminium	3900 mm	I

Plaatsing van het boven- en bodemprofiel

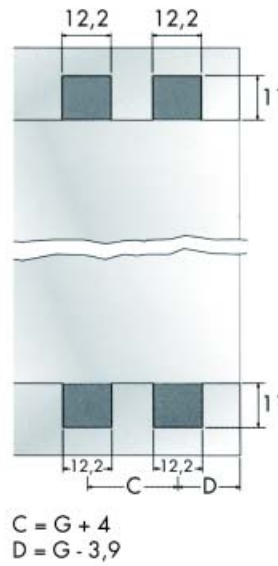
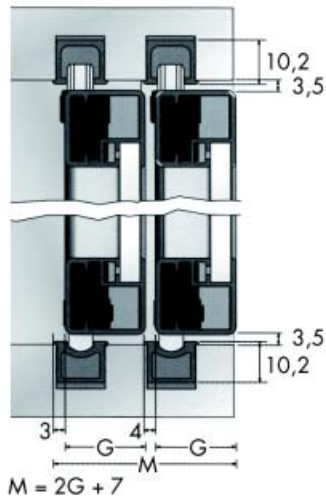

Hoe de hoogte bepalen?

H = hoogte van de kast in mm
 A = hoogte van de deur in mm
 L = breedte van de kast in mm
 B = breedte van de deur in mm
 S = houtdikte in mm
 P = profieldikte in mm
Formule: $A = H - 2S - 10,2$

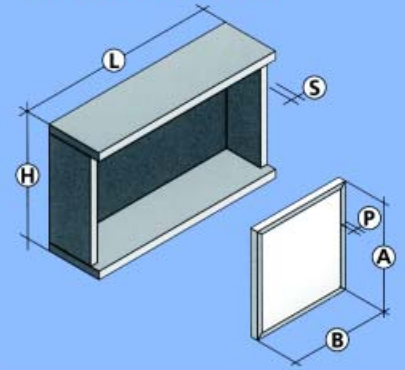

Montage:



Plaats het glas in de verticale deurprofielen.



Schroef de horizontale deurprofielen vast.



Plaats de geleiders in de bovenste horizontale deurprofielen.



Plaats de wielen in de onderste horizontale deurprofielen.



Plaats de stoppers in de bovenprofielen.



Plaats de bovenprofielen in het bovenpaneel.



Plaats de bodemprofielen in het bodempaneel.



Plaats de binnenste deur in de binnenste profielen.



Plaats de buitenste deur in de buitenste profielen.



Pas de hoogte van de wielen aan d.m.v. de regelschroef.



Zet de deur vast d.m.v. de regelschroef van de geleiders.



Schroef de stoppers vast op de juiste plaats.

GREEPPROFIELEN

VERBORGEN GREEPPROFIELEN

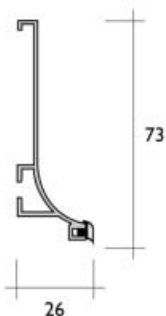
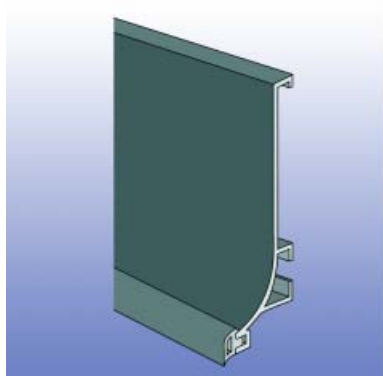

Verborgen greepprofiel type 8200

- voorzien van rubberen stootrand

Bestelnr.	Afwerking	Lengte	Verpakking
047174	aluminium	3900 mm	20

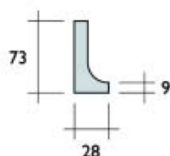

Eindkap voor verborgen greepprofiel type 8200

- per set van 2

Bestelnr.	Afwerking	-	Verpakking
047178	grijs		50

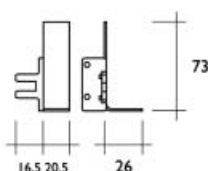

Bevestiging voor verborgen greepprofiel type 8200

- per set

Bestelnr.	Afwerking	-	Verpakking
047176	zwart		50

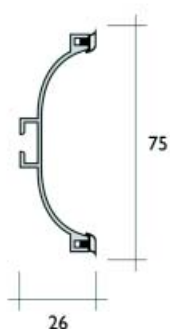
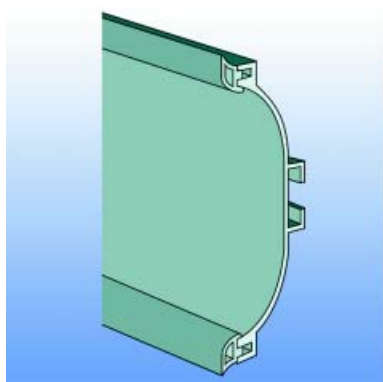

Verborgen greepprofiel type 8300

- voorzien van rubberen stootrand

Bestelnr.	Afwerking	Lengte	Verpakking
047175	aluminium	3900 mm	20

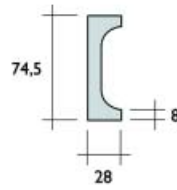

Eindkap voor verborgen greepprofiel type 8300
- per set

Bestelnr.	Afwerking	-	Verpakking
047179	grijs		50

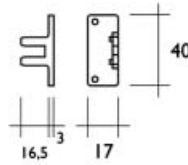

Bevestiging voor verborgen greepprofiel type 8300
- per set

Bestelnr.	Afwerking	-	Verpakking
047177	zwart		50

HOUTEN GREEPPROFIELEN

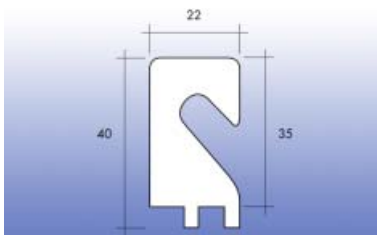

Houten greepprofiel type 9413

Bestelnr.	Afwerking	Lengte	Verpakking
053771	wit Amerikaanse eik	2450 mm	1

GREEPLIJSTEN EN VERSTEVIGINGSPROFIELEN



Greeplijst en verstevigingsprofiel
- voor houtdikte 18 mm

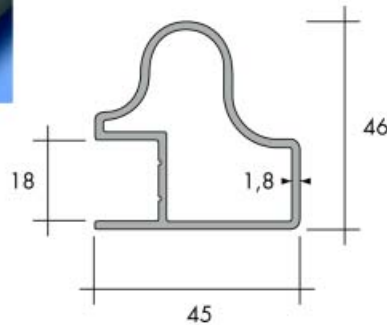
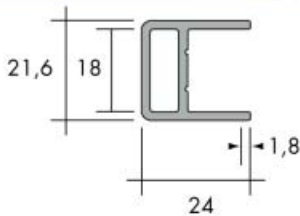

verstevigingsprofiel

greeplijst

Bestelnr.	Afwerking	Omschrijving	Lengte	Verpakking
046279	zilver	greeplijst	2500 mm	1
046282	zilver	verstevigingsprofiel	2500 mm	1
046286	wit	greeplijst	2500 mm	1
046287	wit	verstevigingsprofiel	2500 mm	1
046554	brons	greeplijst	2500 mm	1
046555	brons	verstevigingsprofiel	2500 mm	1

PROFIELEN VOOR WERKBLADEN

PROFIELEN VOOR WERKBLADEN

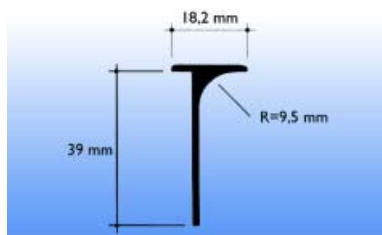

Aluminium profiel type 921.820

Bestelnr.	Afwerking	Lengte	Verpakking
045454	alu naturel	630 mm	1
046263	wit	630 mm	1

AFWERKPROFIELEN

ALUMINIUM AFWERKPROFIELEN

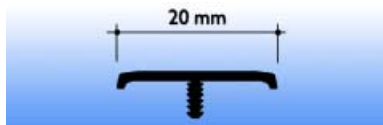

Afboordprofiel

Bestelnr.	Afwerking	Lengte	Verpakking
045006	aluminium	5000 mm	I



Winkelhaak type Elitra

Bestelnr.	Afwerking	Lengte	A	B	Verpakking
045014	aluminium	6000 mm	15 mm	15 mm	I
045015	aluminium	6000 mm	20 mm	20 mm	I
045016	aluminium	6000 mm	25 mm	25 mm	I

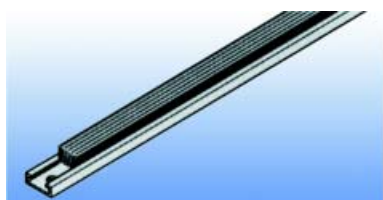

Stoflijst

- aluminium draagprofiel
- grijze borstel

Bestelnr.	Afwerking	Lengte	Verpakking
046283	aluminium	2500 mm	I

KUNSTSTOF AFWERKPROFIELEN

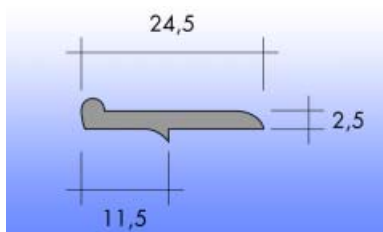

Makelaarsprofiel type 10.1347

Bestelnr.	Afwerking	Lengte	Verpakking
011378	bruin	4000 mm	600 m
011377	wit	4000 mm	600 m

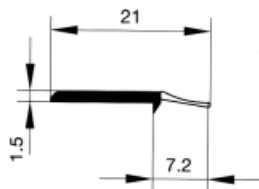

Makelaarsprofiel met zachte lip type 740038

- zelfklevend

Bestelnr.	Afwerking	Lengte	Verpakking
013095	wit	3600 mm	I

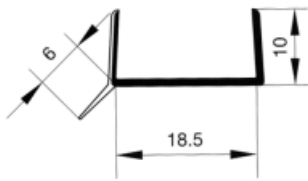

U-profiel voor sokkels type 720066
- zachte lip

Bestelnr.	Afwerking	Lengte	Voor sokkeldikte	Verpakking
010055	bruin	5000 mm	18 mm	600
013039	transparant	5000 mm	18 mm	600
012701	wit	5000 mm	18 mm	600
012702	zwart	5000 mm	18 mm	600

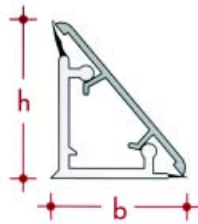
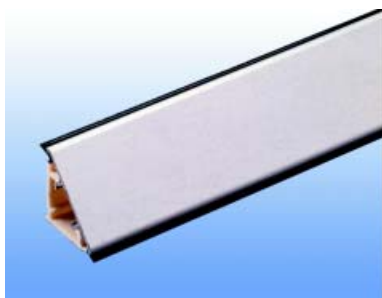

Wandafsluitprofiel type 3500
- onderdelen apart te bestellen

Bestelnr.	Afwerking	Omschrijving	Lengte	Verpakking
013229	wit	wandafsluitprofiel	4000 mm	100
013230	wit	Eindkappen (links+rechts)		2
013231	wit	binnenhoek		1
013232	wit	buitenhoek		1

ALUMINIUM KADERPROFIEL

ALUMINIUM KADERPROFIEL EN TOEBEHOREN

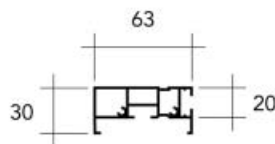
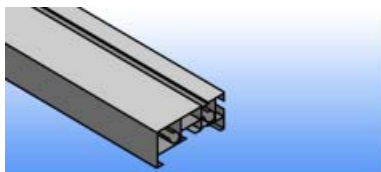
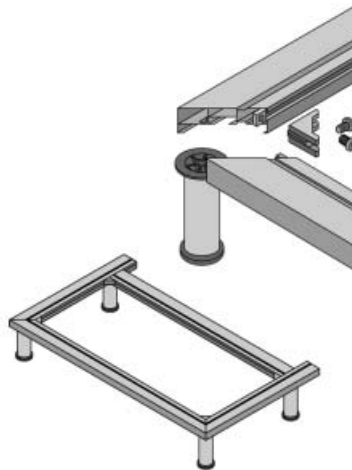

Kaderprofiel type 6554

- per doos van 10 lengtes

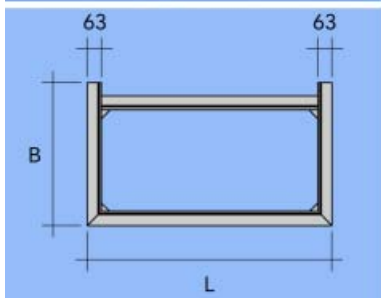

Bestelnr.	Afwerking	Lengte	Verpakking
047237	aluminium	3900 mm	I

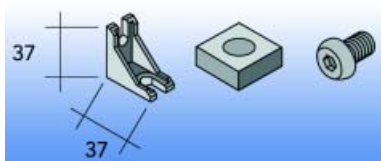

Set verbindingen voor kaderprofiel type 6554

- set bevat:
 4 wijkelhaken
 8 vierkant-moeren
 8 verzinkte schroeven

Bestelnr.	Afwerking		Verpakking
047238	aluminium	-	I

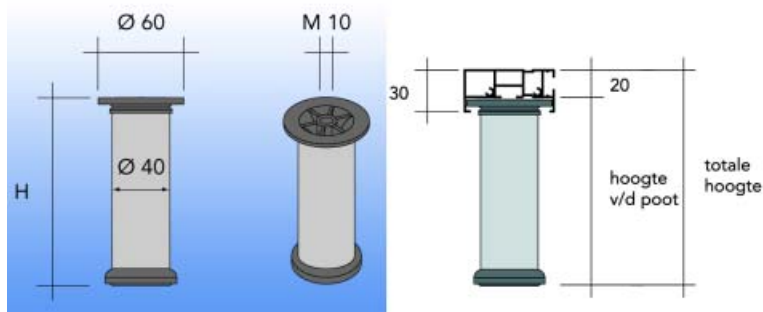

Set van 4 poten voor kaderprofiel type 6554

- de afstand van de vloer tot de kast is de hoogte van de poot + 20 mm
- ± 1,5 cm regelbaar in de hoogte

Bestelnr.	Afwerking	Hoogte H	Verpakking
047239	aluminium	130 mm	1
047240	aluminium	150 mm	1

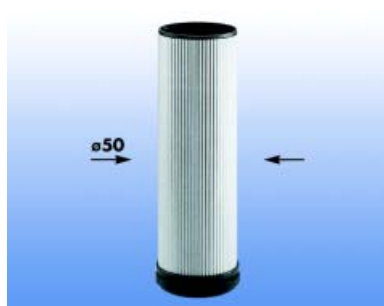

Camar poot type 550 AO

- indien u het kaderprofiel wil combineren met de Camar poot type 550 AO, dient u gebruik te maken van de bevestigingsschroef type V10MQ17Z

Bestelnr.	Afwerking	Hoogte	Regelbaar	Verpakking
021792	aluminium	100 mm	30 mm	80
021795	aluminium	150 mm	30 mm	80
021798	aluminium	200 mm	30 mm	40
021801	aluminium	250 mm	30 mm	40



Bevestigingsschroef type V10MQ17Z

- bevestigingsschroef voor Camar poot type 550 AO

Bestelnr.	Afwerking	-	Verpakking
047249	alu		1

ALUMINIUM PLINTPROFIEL

ALUMINIUM PLINTPROFIEL

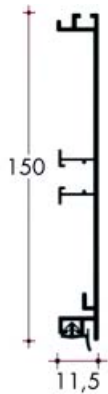

Plintprofiel type R4070

- per doos van 10 stuks

Bestelnr.	Afwerking	Lengte	Verpakking
047228	aluminium	4100 mm	doos

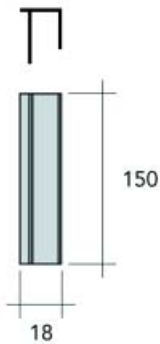
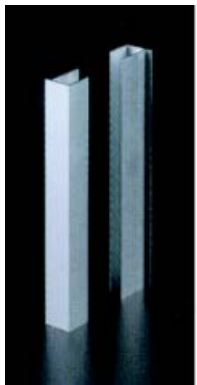

Eindkap type I300 voor plint

Bestelnr.	Afwerking	-	Verpakking
047231	aluminium		1

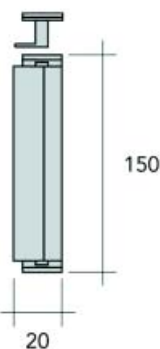

Rechte verbinding type K1321 voor plint

Bestelnr.	Afwerking	-	Verpakking
047230	aluminium		1

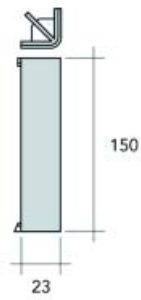
Buitenhoekverbindingen 90° type K1340 voor plint

- set bevat 2 buitenhoeken

Bestelnr.	Afwerking	-	Verpakking
047229	aluminium		I

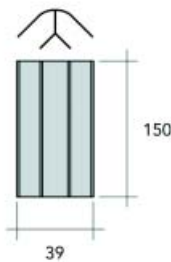
Binnenhoekverbindingen 90° type K1340 voor plint

- set bevat 2 binnenhoeken

Bestelnr.	Afwerking	-	Verpakking
047274	aluminium	-	I



Plintklem type 226/00/24 voor plint

Bestelnr.	Afwerking	Diameter	Verpakking
021913	zwart	28 mm	800

UITTREKTAFELBESLAG

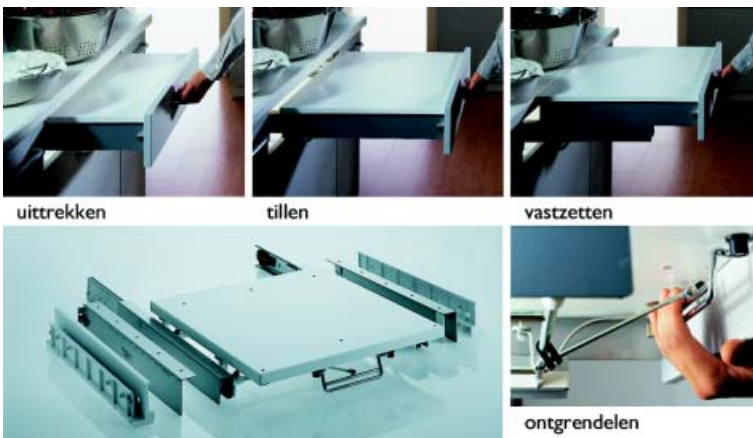

UITTREKBESLAG



Uittrekbeslag 1

- het tafelblad komt op dezelfde hoogte van het werkblad
- zonder werkblad
- afmetingen voor werkblad: 555 x 460 x 16 mm
- dikte van het werkblad: 15-19 mm
- uittrekbaar deel 585 mm

Bestelnr.	Afwerking	Draagkracht	Inbouwbreedte	Inbouwdiepte	Inbouwhoogte	Referentie	Verpakking
050857	wit	20 KG	562-568 mm	min.500 mm	min.110 mm	5124	1

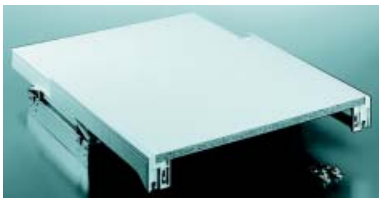

Uittrekbeslag 2

- zelfdragend
- volledig met tafelblad
- uittrekbaar deel 830 mm

Bestelnr.	Afwerking	Draagkracht	Corpusdiepte	Corpusbreedte	Referentie	Verpakking
050858	wit	15 KG	min.500 mm	567 mm	7594	5



Uittrekbeslag 3

- met vast ladefront
- uittrekbaar deel 820 mm

Bestelnr.	Afwerking	Draagkracht	Corpusdiepte	Corpusbreedte	Referentie	Verpakking
035010	verzinkt	30 KG	520 mm	820 mm	7583	1
035011	verzinkt	30 KG	420 mm	620 mm	7585	1



Uittrektafel type Rapid 3845

Bestelnr.	Afwerking	Voor kastbreedte	Inbouwmaten BxDxH	Uittreklak	Draagkracht	Verpakking
046801	wit/grijs	600 mm	561 x 490 x 120 mm	521 x 800 mm	100 KG	I



Uittrektafel type Presto 3856

Bestelnr.	Afwerking	Voor kastbreedte	Inbouwmaten BxDxH	Uittreklak	Werkhoogte	Draagkracht	Verpakking
035199	wit/grijs	600 mm	561 x 504 x 195 mm	521 x 1110 mm	635-735 mm	110 KG	I

Poten voor Uittrektafel type Presto 3856

Bestelnr.	Afwerking	Hoogte	Verpakking
035200	grijs	615 - 875 mm	12 sets

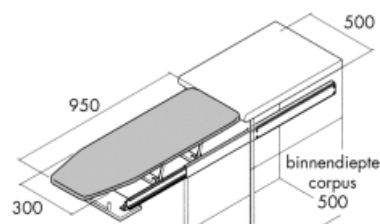

Opklapbaar strijktafelbeslag type 568

Bestelnr.	Afwerking	Inbouwbreedte	Inbouwdiepte	Strijkplank	Verpakking
035276	wit	300 mm	950 mm	wit/grijs	I